



# **User's manual**

TL7800

DECT 6.0

accessory cordless headset

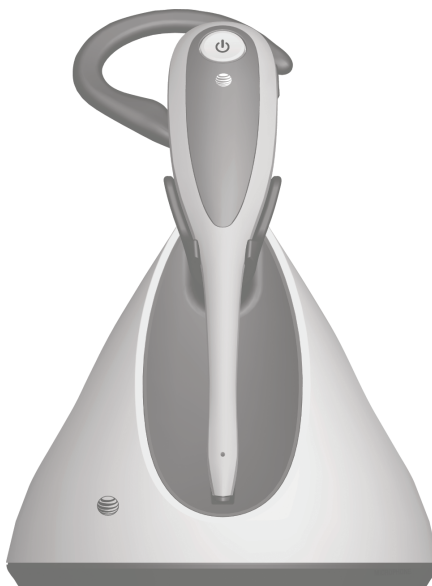

# Congratulations

on your purchase of this AT&T product.

Enjoy up to 12 hours of hands-free talk time and crystal-clear sound quality with the AT&T TL7800 DECT 6.0 Accessory Cordless Headset. Pair it wirelessly with AT&T DECT phone, including the Synapse® or SynJ® business phone system. Easy one-button answer, volume and mute controls enhance wireless freedom, while a range of up to 500 feet maximizes mobility. A magnetic charger in the cradle ensures the headset fits and charges securely—so you'll never run out of battery during long calls. Lightweight and comfortable, the headset offers multiple wearing styles: over the ear, over the head or behind the neck.

Before using this AT&T product, please read the **Important safety information** section on pages 39-41 of this manual. Please thoroughly read this user's manual for the feature operations and troubleshooting information necessary to install and operate your new AT&T product. You can also visit our website at **[www.telephones.att.com/smb](http://www.telephones.att.com/smb)** or call **1 (800) 222-3111**. In Canada, dial **1 (866) 288-4268**.

This telephone meets the California Energy Commission regulations for energy consumption. Your telephone is set up to comply with the energy-conserving standards right out of the box. No further action is necessary.

Visit **[www.smbtelephones.att.com/compatibility-finder](http://www.smbtelephones.att.com/compatibility-finder)** for a complete list of AT&T phones that have been tested and found to be compatible with the TL7800.

Model number: TL7800

Type: DECT 6.0 accessory cordless headset

Serial number: \_\_\_\_\_

Purchase date: \_\_\_\_\_

Place of purchase: \_\_\_\_\_

Both the model and serial numbers of your AT&T product can be found on the bottom of the headset charger.

Save your sales receipt and original packaging in case it is necessary to return this product for warranty service.



Telephones identified with this logo have reduced noise and interference when used with most T-coil equipped hearing aids and cochlear implants. The TIA-1083 Compliant Logo is a trademark of the Telecommunications Industry Association. Used under license.

# Parts checklist

Check to make sure the headset package includes the following items. Save your sales receipt and original packaging in the event warranty service is necessary.

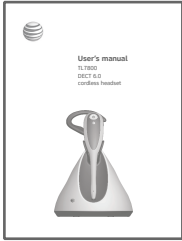

User's manual

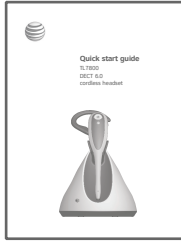

Quick start guide



Cordless headset  
with earbud attached



Headset charger



Battery with battery  
compartment cover attached

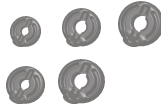

Five earbuds



Headset charger  
power adapter



Three over the ear hooks



Two over the head bands



Behind the neck band



# User's manual

TL7800

DECT 6.0

accessory cordless headset

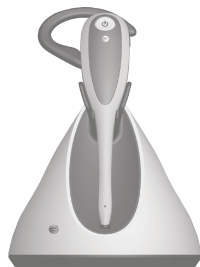

## Table of contents

### Getting started

Quick reference guide - headset.....	1
Headset lights .....	1
Headset alert tones.....	3
Quick reference guide - headset charger.....	4
Installation.....	5
Battery installation.....	6
Headset charger installation and battery charging.....	7
Adding and registering headsets .....	8
Register a headset to the TL7810/TL7812 headset base.....	9
Register a headset to the Synapse SB67030/ SB67031 deskset.....	10
Register a headset to the SynJ SB67138/ SB67158 base.....	11
Register a headset to an AT&T DECT cordless telephone base .....	13

Deregistering headset.....	15
Deregister all headsets from the TL7810/TL7812 headset base.....	15
Deregister headset from the Synapse SB67030/ SB67031 deskset .....	16
Deregister headset from the SynJ SB67138/ SB67158 base.....	17
Deregister all headsets from an AT&T DECT cordless telephone base ....	18
Headset attachments .....	19
Earbud.....	19
Over the ear hook.....	20
Over the head band.....	23
Behind the neck band.....	25

### Operation

Headset operation .....	28
Power on/off the headset.....	28
Make a call.....	28
Answer a call.....	28

End a call.....	28
Headset ringer .....	29
Temporary ringer silencing.....	29
Call waiting.....	29
Options while on calls.....	30
Volume control.....	30
Mute .....	30
Multiple headsets use .....	31

## Index

Index .....	56
-------------	----

## Appendix

Troubleshooting .....	32
Maintenance.....	38
Important safety information.....	39
Safety information.....	39
Especially about cordless headsets .....	40
Precautions for users of implanted cardiac pacemakers .....	41
Pacemaker patients.....	41
For C-UL compliance.....	42
Mesures de sécurité importantes.....	42
FCC Part 68 and ACTA.....	46
FCC Part 15.....	48
California Energy Commission battery charging testing instructions.....	49
Limited warranty.....	52
Technical specifications .....	55
DECT 6.0 digital technology.....	55
Operating range.....	55
Extended range and clarity .....	55

## Quick reference guide - headset

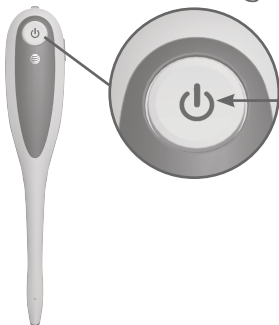

**⏻ (On/off button and light)**

Press to make, answer or end a call (page 28).

**Headset lights**

⏻ light status	
Red	<ul style="list-style-type: none"> <li>• On when the headset is charging in the headset charger.</li> <li>• Flashes every 10 seconds to indicate the battery is low when the headset is not in the headset charger.</li> <li>• Flashes three times to indicate the headset is powering off.</li> </ul>
Blue	<ul style="list-style-type: none"> <li>• On when a fully charged and registered headset is in the headset charger.</li> <li>• Flashes three times to indicate the headset is powering on.</li> <li>• Flashes twice every three seconds when the headset is in use.</li> <li>• Flashes four times every four seconds when there is an incoming call.</li> <li>• Flashes every 10 seconds when a fully charged and registered headset in idle mode is out of the headset charger.</li> </ul>
Red and blue	<ul style="list-style-type: none"> <li>• Flashes slowly when the headset is not registered.</li> <li>• Flashes quickly when the headset is trying to register to a headset base or telephone base.</li> </ul>
Off	<ul style="list-style-type: none"> <li>• The battery is dead.</li> <li>• No battery is installed.</li> <li>• The headset is powered off.</li> </ul>

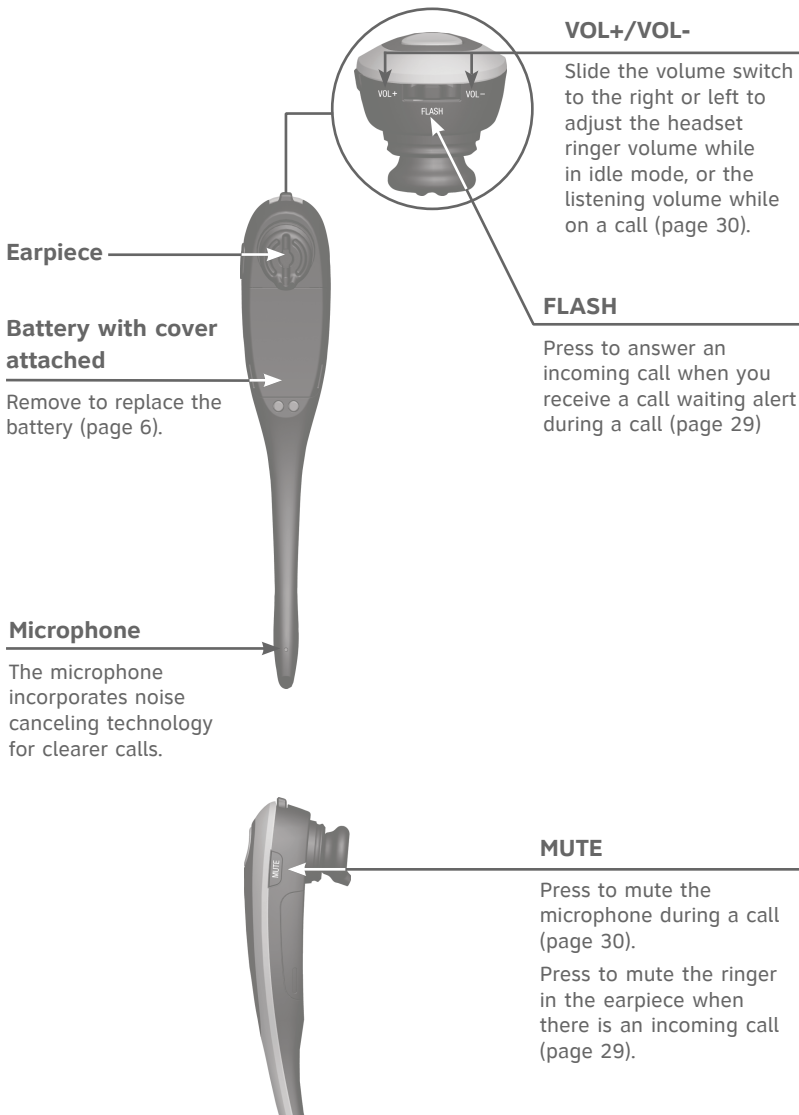
# Quick reference guide - headset



## Quick reference guide - headset

**Headset alert tones**

One short beep every 30 seconds	<ul style="list-style-type: none"> <li>• The microphone is muted.</li> </ul>
Two beeps	<ul style="list-style-type: none"> <li>• Error alert tone.</li> <li>• The ringer volume has reached its lowest setting.</li> <li>• The listening volume has reached its highest or lowest setting.</li> <li>• The speaking volume has reached its highest or lowest setting.</li> <li>• Any key is pressed while the headset is out of range.</li> </ul>
Two low beeps	<ul style="list-style-type: none"> <li>• Call waiting alert tone.</li> </ul>
Two rapid beeps every 20 seconds	<ul style="list-style-type: none"> <li>• Low battery warning.</li> </ul>
Three rising beeps	<ul style="list-style-type: none"> <li>• A conference call has started.</li> </ul>
Three rapid beeps every 20 seconds	<ul style="list-style-type: none"> <li>• The headset is out of range.</li> <li>• The headset is not yet registered.</li> </ul>
Three rapid beeps	<ul style="list-style-type: none"> <li>• The headset is powering on or off.</li> </ul>

## Quick reference guide - headset charger

### **Magnetic charging mount**

Place the headset here for charging.



### **Power cord slot**

Route the power cord through the slot.

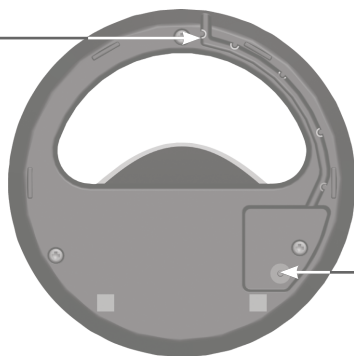

## Installation

You must install and charge the battery before using the headset.



See pages 6-7 for easy instructions.

For customer service or product information, visit our website at [www.telephones.att.com/smb](http://www.telephones.att.com/smb) or call **1 (800) 222-3111**. In Canada, dial **1 (866) 288-4268**.

### **Avoid placing the telephone base too close to:**

- Communication devices such as television sets, VCRs or other cordless telephones.
- Excessive heat sources.
- Noise sources such as a window with traffic outside, motors, microwave ovens, refrigerators or fluorescent lighting.
- Excessive dust sources such as a workshop or garage.
- Excessive moisture.
- Extremely low temperature.
- Mechanical vibration or shock such as on top of a washing machine or work bench.

## Battery installation

The battery is permanently attached to the battery compartment cover. Do not try to separate them from each other. After installing the battery, charge it for at least 15 minutes. You may be able to make and receive short calls. For optimal performance, charge the headset battery for at least three hours before use. When fully charged, the headset battery provides approximately 12 hours of talk time or 5 days of standby time. **When the headset is not in use, recharge it by returning it to the headset charger.**

1. Insert the battery into the battery compartment.

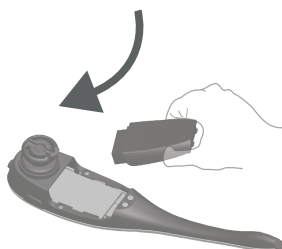

2. Press down on the battery until it clicks into place.

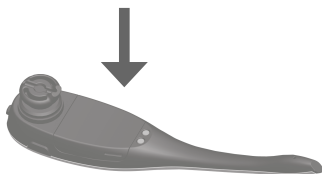

### NOTES:

- Remove any headset attachment, except the earbud, before battery replacement.
- To order a replacement battery (model BT191665), visit our website at **[www.telephones.att.com/smb](http://www.telephones.att.com/smb)** or call **1 (800) 222-3111**. In Canada, dial **1 (866) 288-4268**.



## Headset charger installation and battery charging

After installing the battery, charge the headset by placing it in the magnetic charging mount, as shown below. The  light turns on when the headset is charging.

1. Plug the small end of the headset charger power adapter into the power jack at the bottom of the headset charger. Route the power cord through the power cord slot. Plug the large end of the power adapter into an electrical outlet not controlled by a wall switch.

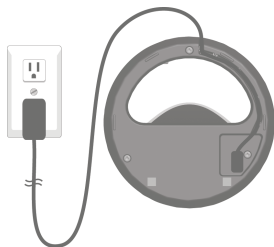

2. Insert the headset into the magnetic charging mount.

Magnetic  
charging mount

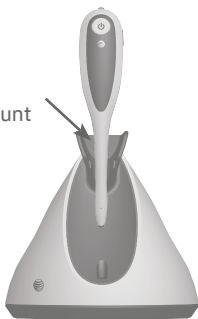

3. The magnet holds the top of the headset in place. The  light turns on.

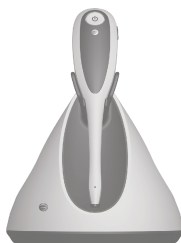

### IMPORTANT INFORMATION

Use only the supplied rechargeable battery pack or replacement battery pack (model BT191665). To order, visit our website at

**[www.telephones.att.com/smb](http://www.telephones.att.com/smb)** or call

**1 (800) 222-3111.** In Canada, dial **1 (866) 288-4268.**

## Adding and registering headsets

You must register your new TL7800 headset to one of the following devices before use:

- AT&T TL7810/TL7812 cordless headset (see page 9). You can register a maximum of two headsets to each headset base.
- Synapse SB67030/SB67031 deskset (see page 10).
- SynJ SB67138/SB67158 base (see pages 11-12).
- A compatible AT&T DECT 6.0 cordless telephone (see pages 13-14). Visit

**[www.smbtelephones.att.com/compatibility-finder](http://www.smbtelephones.att.com/compatibility-finder)** for a list of compatible telephones.

Refer to the user's manual of your telephone for the maximum number of handsets and headsets that you can register to the telephone. If you have the maximum number of handsets/headsets registered, you need to follow the deregistration instructions (see pages 15-18) to deregister all registered devices before you can register this new headset.

You can only register the headset to one device at a time. You must deregister the headset before registering it to another headset base or telephone.

## Adding and registering headsets

### **Register a headset to the TL7810/TL7812 headset base**

---

1. Make sure the battery is properly installed in the headset (see page 6). The **Ⓢ** light flashes slowly in red and blue to indicate the headset is not registered.
2. Place the headset in the headset charger and allow it to charge for at least one hour before beginning registration.
3. Remove the headset from the headset charger.
4. Press and hold the **PAIR** button on the headset base that is registering this headset (about four seconds). When the **MUTE** light on that headset base turns on, release the button.
5. Return the headset to the headset charger for registration. The **Ⓢ** light flashes quickly in red and blue.

It takes about 60 seconds to complete the registration process. The **Ⓢ** light turns red when the headset is registered but not fully charged, or turns blue when it is registered and fully charged.

If the registration fails, you hear the voice prompt "Not registered" when you press the **Ⓢ** button on the headset, and the **Ⓢ** light on the headset flashes slowly in red and blue.

To reset the headset, remove it from the headset charger and try the registration process again.

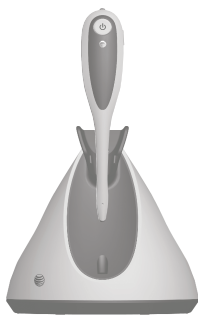

**NOTE:** You cannot register a headset if another system headset is in use.

## Adding and registering headsets

### Register a headset to the Synapse SB67030/SB67031 deskset



1. Press **MENU** on the deskset.
2. Scroll to **User Settings**, then press **SELECT**.
3. Scroll to **Cordless Settings**, then press **SELECT**.
4. Scroll to **Headset**, then press **SELECT**.

Make sure the screen shows **Cordless Headset is currently Not Registered** before registration.

If the screen shows **Cordless Headset is currently Registered**, there is already a registered cordless headset. Refer to the deregistration instructions on page 16 to deregister the old headset before registering a new one.

5. On the deskset, press **Register**. The screen displays **Registration in Progress...** while the deskset is searching for the headset.
6. Lift the headset from the headset charger, then replace it to the charger. The headset  light flashes red and blue to indicate it is registering to the deskset.
7. When registration is complete, the screen displays **Cordless Headset is currently Registered**.

It takes about 60 seconds to complete the registration process. The  light turns red when the headset is registered but not fully charged, or turns blue when it is registered and fully charged.

To verify the registration, press the  button on the headset and check for a dial tone. If the registration fails, you hear the voice prompt, "Not registered" and the  light on the headset flashes slowly in red and blue.



If the registration was not successful, remove it from the headset charger and try the registration process again.

## Adding and registering headsets

### Register a headset to the SynJ SB67138/SB67158 base

1. Place the headset in the headset charger and allow it to charge for at least five minutes before beginning registration. Make sure the headset is out of the headset charger before you begin registration.
2. On the telephone base, press **MENU/ENTER**.
3. Scroll down to **Registration** and then press **MENU/ENTER**.
4. Press **MENU/ENTER** again to select **Register HS**. The telephone base shows **Registering new device...**
5. Place the headset into the charger. It takes up to 60 seconds to complete the registration. The telephone base shows **Cordless headset registered** and beeps when the registration is successful.

It takes about 60 seconds to complete the registration process. The  light turns red when the headset is registered but not fully charged, or turns blue when it is registered and fully charged.

To verify the registration, press the  button on the headset and check for a dial tone. If you hear a dial tone and the extension  icon appears on the telephone base, the registration was successful. If the registration fails, you hear the voice prompt, "Not registered" and the  light on the headset flashes slowly in red and blue.

```
^
COUM
Speed dial setup
Customer support
>Registration
```

```
>Register HS
Deregistration
```

```
Registering
new device...
```

```
Cordless headset
registered
```

```
Line1 00:00:05
```



## Adding and registering headsets



### **Register a headset to the SynJ SB67138/SB67158 base (cont.)**

If the registration was not successful, remove it from the headset charger and try the registration process again.

If you have a dial tone but an extension number other than 0 displays on the telephone base, the headset is registered as a handset and will not function properly. If this is the case, you must deregister and start over. See the deregistration procedures on page 17.

## Adding and registering headsets

### Register a headset to an AT&T DECT cordless telephone base

1. Make sure the battery is properly installed in the headset (see page 6). The  light on the headset flashes slowly in red and blue to indicate the headset is not registered.
2. Place the headset in the headset charger and allow it to charge for at least one hour before beginning registration.
3. Remove the headset from the charger.
4. On the telephone base of the cordless phone, press and hold  /**HANDSET LOCATOR** or  **FIND HS** until the red **IN USE** light turns on (about four seconds) and then release the button.





#### **If your telephone base has no**

#### **/**HANDSET LOCATOR** or **FIND HS** button:**

Press and hold the **HOLD** button until the screen displays **Registering... Please wait**, then release the button.

#### **-OR-**

Press and hold the  **LOCATOR** button until the screen displays **Registering handset...**, then release the button.

5. Place the headset back to the charger. The  light flashes quickly in red and blue.

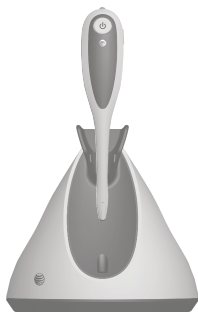



## Adding and registering headsets

### **Register a headset to an AT&T DECT cordless telephone base (cont.)**

---

It takes about 60 seconds to complete the registration process. The  light turns red when the headset is registered but not fully charged, or turns blue when it is registered and fully charged.

To verify the registration, press the  button on the headset and check for a dial tone. If the registration fails, you hear the voice prompt "*Not registered*" and the  light on the headset flashes slowly in red and blue.

To reset the headset, remove it from the headset charger and try the registration process again.



**NOTE:** The button used for registration on your cordless telephone system may be different. Refer to your telephone user's manual for detailed information.



## Deregistering headset

### You may need to deregister your headsets if:

- You have already registered the headset and now wish to register your headset to a different headset base or telephone base.  
**-OR-**
- You have registered the maximum number of headsets and need to replace one of them. You must first deregister all headsets, and then register each headset you wish to use again, one at a time.

**Please read carefully through all the instructions on this page before beginning the deregistration process.**

### Deregister all headsets from the TL7810/TL7812 headset base

1. Press and hold the **PAIR** button on the headset base (at least 10 seconds) until the **MUTE** light on the headset base turns on and starts to flash, then release the **PAIR** button.
2. Immediately press and release the **PAIR** button again. You must press the **PAIR** button while the **MUTE** light is still flashing. (The light flashes for about seven seconds. If the light stops flashing, start again with Step 1.)

It takes about 10 seconds to complete the deregistration process. The  light flashes slowly in red and blue when the deregistration process is successful.

3. To register the headset(s) to the headset base again, follow the registration instructions on page 9.



#### **NOTES:**

- You cannot deregister the headset(s) if any system headset is in use.
- Even if the battery is depleted, you can still deregister the headset by following the steps mentioned above.

## Deregistering headset

### Deregister headset from the Synapse SB67030/SB67031 deskset

1. Press **MENU** on the deskset.
2. Scroll to **User Settings**, then press **SELECT**.
3. Scroll to **Cordless Settings**, then press **SELECT**.
4. Scroll to **Headset**, then press **SELECT**. The screen shows **Cordless Headset is currently Registered**.
5. On the deskset, press **DeReg**. The screen displays **Are you sure you want to deregister the Cordless Headset?**
6. Press **Yes** to confirm deregistration.
7. It takes about 10 seconds to complete the deregistration process. The screen displays **Cordless Handset is currently Not registered** and the headset  $\phi$  light flashes slowly in red and blue when the deregistration process is successful.
8. Press **Exit** on the deskset to return to the previous menu.

# Deregistering headset

## Deregister headset from the SynJ SB67138/SB67158 base

If you already have 10 registered devices and need to replace or add a new device, or if you wish to change the assigned extension numbers of your devices, you must deregister the desired device(s) first, then register the device(s) you wish to use, one at a time. Deregistering a cordless handset or deskset does not remove the data saved on that device.

Please make sure the telephone system is not in use before deregistration. To deregister a headset from the telephone base:

1. On the telephone base, press **MENU/ENTER**.
2. Scroll down to **Registration** and press **MENU/ENTER**.
3. Scroll down to **Deregistration** and then press **MENU/ENTER**.
4. The telephone base screen shows **Deregister:**. Scroll to choose the desired headset, then press **MENU/ENTER**.
5. The telephone base screen prompts if you want to deregister the headset. Press **◀REP** to exit or press **SKIP▶** to continue the deregistration.
6. If you press **SKIP▶**, the telephone base shows **Deregistering**. It takes up to 10 seconds to complete the deregistration. When the deregistration is successful, there is a confirmation tone and the telephone base shows the deregistration completion message.

```

^
COUM
Speed dial setup
Customer support
>Registration
  
```

```

^
Register H5
>Deregistration
  
```

```

^
Deregister:
>Headset 1
Deskset 2
All
  
```

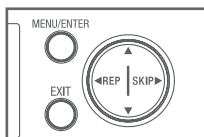

```

Deregister
Headset 1?
<No           >Yes
  
```

```

Deregistering
  
```

```







Headset 1
deregistered
  
```

## Deregistering headset

### Deregister all headsets from an AT&T DECT cordless telephone base

---

Following the steps, as mentioned below, will deregister all the headsets and handsets registered to the cordless phone.

1. Press and hold  /**HANDSET LOCATOR** or  **FIND HS** on the telephone base for about 10 seconds until the **IN USE** light starts to flash, then release the button.
2. Immediately press  /**HANDSET LOCATOR** or  **FIND HS** again. You must press  /**HANDSET LOCATOR** or  **FIND HS** while the **IN USE** light is still flashing. (The light flashes for about five seconds. If the light stops flashing, start again with step 1.)

**If your telephone base has no  /HANDSET LOCATOR or  FIND HS button:**

- i. Press and hold the **FLASH** button until the screen displays **Deregister all handsets?**, then release the button.
- ii. Press **YES** softkey.

**-OR-**

- i. Press and hold the  **LOCATOR** button until the screen displays **Registering handset...** followed by **Deregister all handsets?**, then release the button.
- ii. Immediately press and release **MENU/SELECT** again.

It takes about 10 seconds to complete the deregistration process. The  light flashes slowly in red and blue when the deregistration process is successful.



#### NOTES:

- You cannot deregister the headset(s) if any system handset/headset is in use.
- Even if the battery is depleted, you can still deregister the headset by following the steps mentioned above.
- The button used for deregistration on your cordless telephone system may be different. Refer to your telephone user's manual for detailed information.

## Headset attachments

### Earbud

---

There are a total of six earbuds provided. One of them has been attached to the headset. They come in three sizes of which there are two types: one normal and one providing a deeper fit. Follow the steps, as mentioned below, to change the earbud.

#### To remove the earbud from the headset earpiece:

Hold both sides of the earbud. Twist and pull the earbud until it separates from the earpiece.

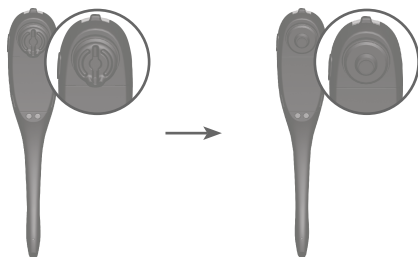

#### To attach the earbud to the headset earpiece:

1. Choose an appropriate earbud.
2. Position the earbud on the earpiece, as shown below.
3. Press the earbud down on the earpiece until it clicks into place. Move the earbud around so that the protruding bump on the earbud is pointing towards your mouth when placed on your ear.

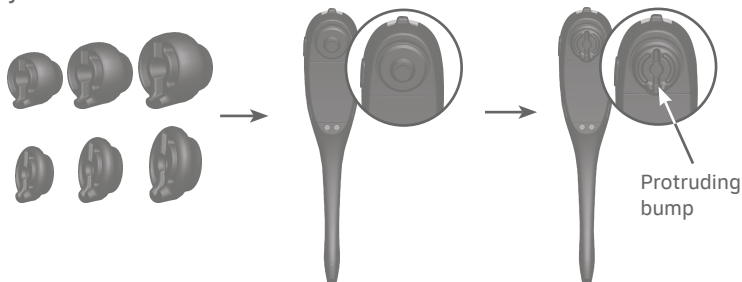

## Headset attachments

### Over the ear hook

---

There are three ear hooks provided. Choose the size that best fits your need to attach to the headset. Follow the steps, as mentioned below, to attach an ear hook to the headset.

#### To position the headset to wear on the left or right ear:

- To wear on the left ear:
  1. Make sure the ear hook loop is positioned, as shown in Figure 1 on the right.
  2. Attach the ear hook to the headset, as instructed on the next page.



Figure 1

- To wear on the right ear:
  1. Make sure the ear hook loop is positioned, as shown in Figure 2 on the right.
  2. Attach the ear hook to the headset, as instructed on the next page.

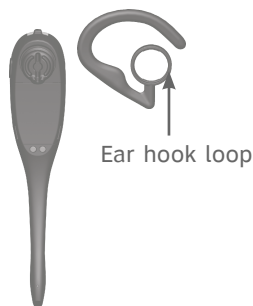

Figure 2

## Headset attachments

### To attach the ear hook to the headset:

1. Make sure there is no headset attachment, except the earbud, connected to the headset.
2. Insert the earpiece into the ear hook loop, as shown in Figure 3.
3. Press the edge of the ear hook loop towards the earpiece until it clicks into place, as shown in Figure 4.
4. Hook the headset onto the desired ear. Adjust the angle of the headset until the microphone is pointing towards your mouth, as shown in Figure 5.

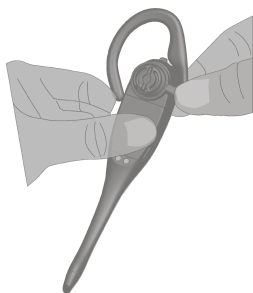

Figure 3

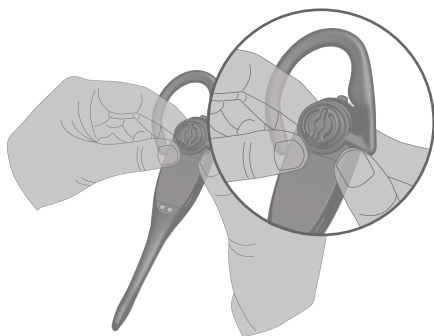

Figure 4

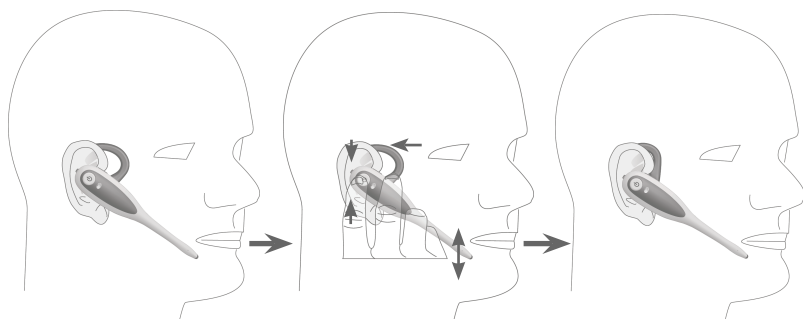
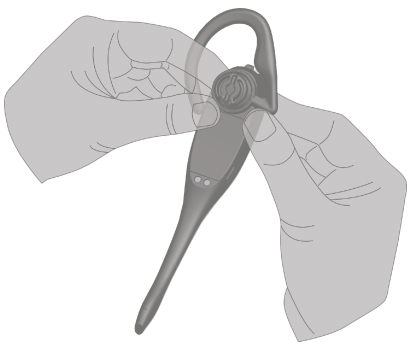

Figure 5

## Headset attachments

### **To remove the ear hook from the headset:**

Hold the headset with one hand. Twist and pull the ear hook with the other hand until it separates from the earpiece.





## Headset attachments

### Over the head band

---

There are two over the head bands provided. Choose the one that best fits your need to attach to the headset. Follow the steps, as mentioned below, to attach an over the head band to the headset.

#### To attach the head band to the headset:

1. Make sure there is no headset attachment, except the earbud, connected to the headset.
2. Insert the earpiece into the loop of the ear pad, as shown in Figure 6.
3. Push the earpiece into the ear pad until it clicks into place, as shown in Figure 7.
4. Adjust the head band to fit your head. Adjust and rotate the angle of the headset until the microphone is pointing towards your mouth, as shown in Figure 8.

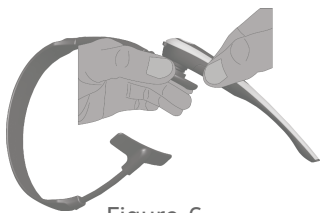

Figure 6

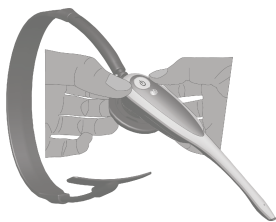

Figure 7

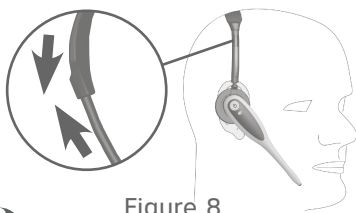

Figure 8



#### NOTES:

- To wear on the other ear, rotate the headset within the loop of the ear pad.
- Firmly grip the ear pad with one hand whenever adjusting the headset microphone up or down.

## Headset attachments

### **To remove the head band from the headset:**

Hold the headset with one hand and the ear pad with the other hand. Twist and pull the headset until it separates from the ear pad.

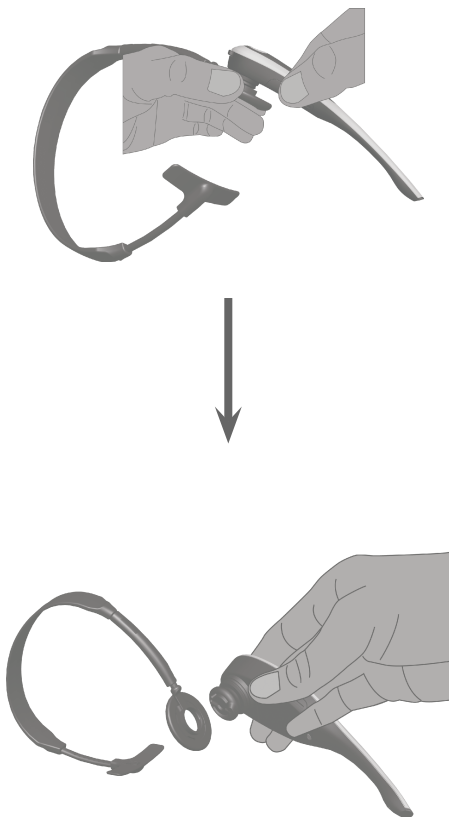

## Headset attachments

### Behind the neck band

---

By default, the ear pad on the neck band is positioned to be worn on the right ear.

#### To attach the headset to the neck band:

1. Make sure there is no headset attachment, except the earbud, connected to the headset.
2. Insert the earpiece into the loop of the ear pad, as shown in Figure 9.
3. Gently press the earpiece inward until it clicks into place, as shown in Figure 10.
4. Place the neck band around your neck and over your ears.
5. Adjust and rotate the angle of the headset until the microphone is pointing towards your mouth, as shown in Figure 11.



Figure 9



Figure 10

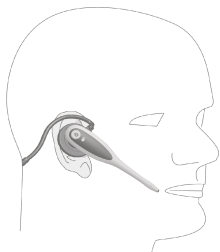

Figure 11

## Headset attachments

### To wear the headset on your left ear:

1. Remove the ear pad and supporting pad from the neck band by carefully pulling them up through the stems at the end of the neck band, as shown in Figure 12.

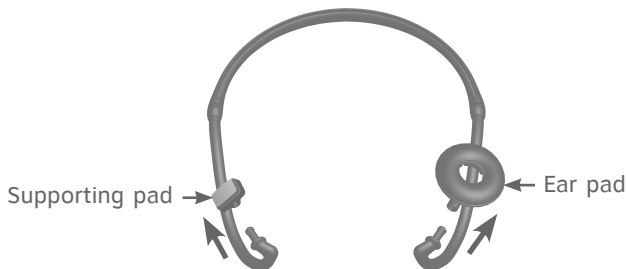

Figure 12

2. Snap the socket of the ear pad into the stem at the left end of the neck band. Snap the socket of the supporting pad into the stem at right end of the neck band, as shown in Figure 13.

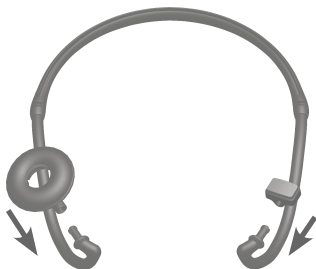

Figure 13

3. Follow Steps 1-5 in **To attach the headset to the neck band** on page 25.

## Headset attachments

### **To remove the neck band from the headset:**

Hold the headset with one hand and the ear pad with the other hand. Twist and pull the headset until it separates from the ear pad.

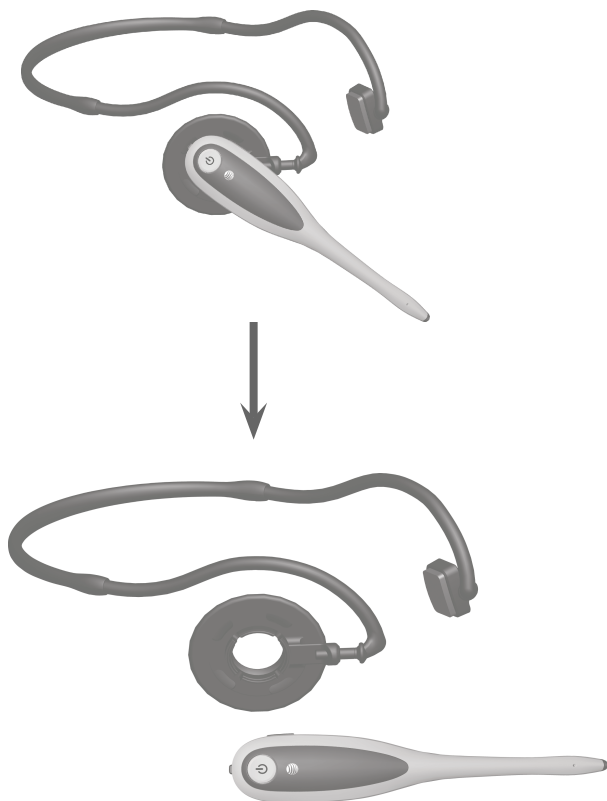

## Headset operation

### Power on/off the headset

---

Power on the headset before use.

#### To power on the headset:

- Place the headset in the headset charger.

**-OR-**

- Press and hold  for two seconds.

The  light flashes blue three times. You hear three beeps when it is being powered on.

Power off the headset if it will not be used for a long time.

#### To power off the headset:

- Press and hold  for four seconds.

The  light flashes red three times. You hear three beeps when it is being powered off.



Prolonged exposure to high volume levels using the headset may damage your hearing.

### Make a call

---

1. Follow the instructions in your telephone user's manual for making calls.
2. Press  on the headset at any time to join the call.
3. After you join the call, you can hang up the telephone and continue the call on the headset.

### Answer a call

---

- Press  on the headset.

### End a call

---

- Press  on the headset or place the headset in the headset charger.

## Headset operation

### Headset ringer

---

The headset charger and headset do not have external ringers. When you receive calls, the headset earpiece rings. If you have telephones connected to the same telephone line as the headset base, you can rely on the ringers of those telephones to alert you to incoming calls.

#### To change the volume of the earpiece ringer:

- Slide the volume switch at the top of the headset towards **VOL+** or **VOL-** when the headset is not in use.

#### To turn off the earpiece ringer:

- Slide the volume switch at the top of the headset towards **VOL-** until you hear two beeps when the headset is not in use.

### Temporary ringer silencing

---

Press **MUTE** to temporarily silence the ringer in the headset earpiece. This silences the ringer without disconnecting the call. The next incoming call rings normally at the preset volume.

### Call waiting

---

If you subscribe to call waiting service offered by your telephone service provider, and someone calls you while you are already on a call, you hear a call waiting alert tone.

- Press down the **FLASH** switch at the top of the headset to put your current call on hold and answer the new call.
- Press the **FLASH** switch again at any time to switch back and forth between calls.



## Options while on calls

### Volume control

---

#### To adjust the listening volume:

- While on a call, slide the volume switch at the top of the headset towards **VOL+** or **VOL-** to adjust the listening volume.



#### NOTES:

- Listening volume settings are independent for each headset.
- When the listening volume reaches the minimum or maximum setting, you hear two beeps.

### Mute

---

The mute function turns off the headset microphone. You can hear the caller, but the caller cannot hear you.

#### To mute a call:

- Press **MUTE** on the headset to turn off the headset microphone. The voice prompt "Mute on" plays. The **MUTE** light on the headset base flashes and a short beep plays every 30 seconds.



#### To take a call off mute:

- Press **MUTE** on the headset to resume the two-way conversation. You hear the voice prompt "Mute off".





## Options while on calls

### Multiple headsets use

---

If you have more than one headset registered to the same headset base or telephone base, when one of the headsets is on an external call, the other headset can join the call in progress.

- To join a call, press  on the headset.
- To end the call, press  or place the headset in the headset charger. The call ends only when all devices hang up.



**NOTE:** The maximum number of devices that can be used on an external call may vary from model to model. Refer to the user's manual of the telephone for more details.

## Troubleshooting

If you have difficulty with your telephone, please try the following suggestions. For customer service, visit our website at **[www.telephones.att.com/smb](http://www.telephones.att.com/smb)** or call **1 (800) 222-3111**. In Canada, dial **1 (866) 288-4268**.

### **My headset doesn't work at all.**

- Make sure the power cord is securely plugged in.
- Make sure that the battery is securely installed in the cordless headset.
- Charge the battery in the cordless headset for at least three hours. For optimum daily performance, return the cordless headset to its charger when not in use.
- Reset the headset. Power off the headset and then power it on.
- Other electronic products such as HAM radios and other DECT phones, can cause interference with your cordless headset. Try installing your headset base or telephone base as far away as possible from these types of electronic devices.
- You may need to purchase a new battery. Refer to page 6 of this user's manual.

### **There is no dial tone.**

- Try all the suggestions mentioned above.
- Move the cordless headset closer to the headset base or telephone base. You might have moved out of range.
- Your telephone line cord may be defective. Install a new telephone line cord.
- Another phone on the same phone line may be in use.
- If the previous suggestions do not work, disconnect the headset base or telephone base from the telephone jack and connect another phone to that jack. If there is no dial tone on that phone either, the problem is in your wiring or telephone service. Contact your telephone service provider.

## Troubleshooting

### **The battery does not charge.**

- Make sure that the battery is securely installed in the cordless headset.
- If the cordless headset is in its headset charger but the **⓪** light on the headset does not turn on, refer to **The ⓪ light on the headset is off while charging** on page 37.
- Charge the battery in the cordless headset for at least three hours. For optimum daily performance, return the cordless headset to the headset charger when not in use.
- You may need a new battery. Refer to the **Battery installation** section on page 6.
- Your headset might be defective. Refer to the **Limited warranty** section on pages 52-54 for further instructions.

### **I cannot dial out.**

- Try all the suggestions mentioned above.
- You may use a telephone on the same line to dial out. Once you have dialed the number, you can press **⓪** to join the call.
- If other phones in your home or office are having the same problem, the problem is in your wiring or telephone service. Contact your telephone service provider (charges may apply).

### **My cordless headset isn't performing normally.**

- Make sure the power cord is securely plugged into the headset charger. Plug the unit into a different working electrical outlet not controlled by a wall switch.
- Move the cordless headset closer to the headset base or telephone base. You might have moved out of range.
- Reset the headset. Power off the headset and then power it on.
- Other electronic products such as HAM radios and other DECT phones, can cause interference with your cordless headset. Try installing your headset base or telephone base as far away as possible from these types of electronic devices.

## Troubleshooting

### **I get noise, static, or a weak signal even when I'm near the telephone base.**

- You may be able to improve the performance of your cordless headset by installing the headset base or telephone base at least one foot from any cordless telephone system. If separating them by one foot does not help, try moving the headset farther away.
- Other electronic products such as HAM radios and other DECT phones, can cause interference with your cordless headset. Try installing your headset base or telephone base as far away as possible from these types of electronic devices.
- Do not use this headset near a microwave oven. You may experience decreased performance while the microwave oven is operating.
- If your headset is located near a modem, move your headset and modem further apart from each other.
- Relocate your headset base or telephone base to a higher location. You may experience better reception by elevating the headset base or telephone base.
- If other phones in your home or office are having the same problem, the problem is in your wiring or telephone service. Contact your telephone service provider (charges may apply).

### **I cannot hear a ring tone from the headset when there is an incoming call.**

- The headset does not have an external ringer. You can only hear the ring tone when you are wearing the earpiece.
- If you have pressed **MUTE** on the headset when it is ringing, it mutes the ring tone of the headset. The ring tone resumes on the next call.
- You may have too many extension phones on your telephone line to allow all of them to ring simultaneously. Try unplugging some of the other phones.

## Troubleshooting

- The layout of your home or office might be limiting the operating range. Try moving the headset base or telephone base to another location, preferably to a higher location.
- Other electronic products such as HAM radios and other DECT phones, can cause interference with your cordless headset. Try installing your headset base or telephone base as far away as possible from these types of electronic devices.
- Install the battery again, and then place the cordless headset in the headset charger. Wait for the cordless headset to reestablish its connection with the headset base or telephone base. Allow up to one minute for this to take place.
- Your telephone line cord may be defective. Install a new telephone line cord.
- If other phones in your home or office are having the same problem, the problem is in your wiring or telephone service. Contact your telephone service provider (charges may apply).
- Test a working phone at the phone jack. If another phone has the same problem, there may be a problem with the phone jack, wiring or service. Contact your telephone service provider (charges may apply).

### **I hear other calls while using my headset.**

- Plug a different telephone into the telephone jack that you are currently using. If you still hear other calls, the problem is probably in your building's wiring or telephone service. Call your telephone service provider.

### **I want to use my headset with a different headset base or telephone base.**

- You need to deregister the headset from the current headset base or telephone base (pages 15-18), and then register it to the new headset base or telephone base (pages 8-14).

## Troubleshooting

### **My calls cut in and out while I'm using my cordless headset.**

- Other electronic products such as HAM radios and other DECT phones, can cause interference with your cordless headset. Try installing your headset base or telephone base as far away as possible from these types of electronic devices.
- Do not use the headset near a microwave oven. You may experience decreased performance while the microwave oven is operating.
- If your headset is located near a modem, move your headset and modem further apart from each other.
- Relocate your telephone base to a higher location. The headset will have better reception when not installed in a low area.
- If other phones in your home or office are having the same problem, the problem is in your wiring or telephone service. Contact your telephone service provider (charges may apply).

### **I cannot register the headset.**

- If you want to register this headset to an AT&T DECT 6.0 telephone, make sure the telephone is compatible with this headset. Visit **[www.smbtelephones.att.com/compatibility-finder](http://www.smbtelephones.att.com/compatibility-finder)** for a list of compatible telephones.
- Your headset base or telephone has a limitation of the number of headsets that can be registered to it. If the maximum number of headsets are already registered, you need to deregister the registered devices before you can register this headset. Refer to the user's manual of the headset base or telephone for more details.

## Troubleshooting

### **The light on the headset is off while charging.**

- Make sure the power cord is plugged in correctly and securely.
- Make sure that the battery is securely installed in the cordless headset.
- Make sure the headset is sitting properly in the charger to charge.
- Unplug the unit's electrical power. Wait for 15 seconds, then plug it back in. Allow up to one minute for the cordless headset and headset charger to reset.
- Clean the cordless headset and headset charger charging contacts each month using a pencil eraser or dry cloth.
- Your headset or headset charger might be defective. Refer to the **Limited warranty** section on pages 52-54 for further instructions.

### **Common cure for electronic equipment.**

- If the unit does not seem to be responding normally, try putting the cordless headset in its charger. If it does not fix the problem, do the following (in the order listed):
  1. Disconnect the power to the headset charger.
  2. Remove the cordless headset battery.
  3. Wait a few minutes.
  4. Connect the power to the headset charger.
  5. Install the battery again, and then place the cordless headset into the headset charger.
  6. Wait for the cordless headset to reestablish its connection with the headset base or telephone base. Allow up to one minute for this to take place.

# Maintenance

## **Taking care of your headset**

- Your cordless headset contains sophisticated electronic parts, so it must be treated with care.
- Avoid rough treatment.
- Place the headset down gently. Save the original packing materials to protect your headset if you ever need to ship it.

## **Avoid water**

- Your headset can be damaged if it gets wet. Do not use the headset outdoors in the rain, or handle it with wet hands. Do not install the headset charger near a sink, bathtub or shower.

## **Electrical storms**

- Electrical storms can sometimes cause power surges harmful to electronic equipment. For your own safety, take caution when using electrical appliances during storms.

## **Cleaning your headset**

- Your headset has a durable plastic casing that should retain its luster for many years. Clean it only with a soft cloth slightly dampened with water or mild soap.
- Do not use excess water or cleaning solvents of any kind.

Remember that electrical appliances can cause serious injury if used when you are wet or standing in water. If the telephone base should fall into water, **DO NOT RETRIEVE IT UNTIL YOU UNPLUG THE POWER CORD AND TELEPHONE LINE CORD FROM THE WALL.** Pull the unit out by the unplugged cords.



# Important safety information



This symbol is to alert you to important operating or servicing instructions that may appear in this user's manual. Always follow basic safety precautions when using this product to reduce the risk of injury, fire, or electric shock.

## Safety information

---

- **Read and understand all instructions in the user's manual. Observe all markings on the product.**
- **Avoid using a headset during a thunderstorm.** There may be a slight chance of electric shock from lightning.
- **Do not use the headset to report a gas leak in the vicinity of the leak.** Under certain circumstances, a spark may be created when the adapter is plugged into the power outlet, or when the headset is replaced in its cradle. This is a common event associated with the closing of any electrical circuit. The user should not plug the headset charger into a power outlet, and should not put a charged headset into the cradle, if the headset charger is located in an environment containing concentrations of flammable or flame-supporting gases, unless there is adequate ventilation. A spark in such an environment could create a fire or explosion. Such environments might include: medical use of oxygen without adequate ventilation; industrial gases (cleaning solvents; gasoline vapors; etc.); a leak of natural gas; etc.
- **Do not use this product near water, or when you are wet.** For example, do not use it in a wet basement or shower, or next to a swimming pool, bathtub, kitchen sink, or laundry tub. Do not use liquids or aerosol sprays for cleaning. If the product comes in contact with any liquids, unplug any line or power cord immediately. Do not plug the product back in until it has dried thoroughly.
- **Install this product in a protected location** where no one can trip over any line or power cords. Protect cords from damage or abrasion.
- **If this product does not operate normally, see the Troubleshooting section on pages 32-37 of this user's manual.** If you cannot solve the problem, or if the product is damaged, refer to the **Limited warranty** section on pages 52-54. Do not open this product except as may be directed in your user's manual. Opening the product or reassembling it incorrectly may expose you to hazardous voltage or other risks.
- **Replace batteries only as described in your user's manual (page 6).** Do not burn or puncture batteries — they contain caustic chemicals.
- **This power adapter is intended to be correctly oriented in a vertical or floor mount position.** The prongs are not designed to hold the plug in place if it is plugged into a ceiling, an under-the-table or a cabinet outlet.

## Important safety information



### CAUTIONS:

- Use only the power adapter provided with this product. To obtain a replacement, visit our website at **[www.telephones.att.com/smb](http://www.telephones.att.com/smb)** or call **1 (800) 222-3111**. In Canada, dial **1 (866) 288-4268**.
- Use only the supplied rechargeable battery or replacement battery (model BT191665). To order, visit our website at **[www.telephones.att.com/smb](http://www.telephones.att.com/smb)** or call **1 (800) 222-3111**. In Canada, dial **1 (866) 288-4268**.
- To prevent risk of fire or battery explosion, replace with the correct battery type. Dispose of used batteries according to the instructions.

### Especially about cordless headsets

---

- **Privacy:** The same features that make a cordless headset convenient create some limitations. Telephone calls are transmitted between the telephone base and the headset by radio waves, so there is a possibility that your cordless headset conversations could be intercepted by radio receiving equipment within range of the cordless headset. **For this reason, you should not think of cordless headset conversations as being as private as those on corded telephones.**
- **Electrical power:** The telephone base of this cordless headset must be connected to a working electrical outlet which is not controlled by a wall switch. **Calls cannot be made from the headset if the telephone base is unplugged or switched off, or if the electrical power is interrupted.**
- **Potential TV interference:** Some cordless headsets operate at frequencies that may cause interference to TVs and VCRs. To minimize or prevent such interference, do not place the telephone base of the cordless headset near or on top of a TV or VCR. If interference is experienced, moving the cordless headset farther away from the TV or VCR will often reduce or eliminate the interference.
- **Rechargeable batteries:** This product contains lithium-ion rechargeable batteries. Exercise care in handling batteries in order not to create a short circuit with conductive material such as rings, bracelets and keys. The battery or conductor may overheat and cause harm. Observe proper polarity between the battery and the battery charger.
- **Lithium-ion rechargeable batteries:** Dispose of these batteries in a safe manner. Do not burn or puncture. Like other batteries of this type, if burned or punctured, they could release caustic material which could cause injury.

## Important safety information



The RBRC® Seal means that the manufacturer is voluntarily participating in an industry program to collect and recycle lithium-ion rechargeable batteries when taken out of service within the United States. These batteries may be taken to a participating local retailer of replacement batteries or recycling center. You may call 1-800-8-BATTERY® for locations accepting spent Li-ion batteries.

RBRC® and 1-800-8-BATTERY® are registered trademarks of the Rechargeable Battery Recycling Corporation.

### CAUTION

- There may be a risk of explosion if you use a wrong type of battery. Use only the supplied rechargeable battery or replacement battery (model BT191665).
- Change this product's batteries only in accordance with the instructions and limitations specified in this manual.
- As with any batteries, do not allow conductive materials such as rings, bracelets or keys to come in contact with the metallic parts of the battery. The battery or conductor may overheat and cause harm.
- Do not open or damage the batteries. Released electrolyte is corrosive and may cause injury to the eyes or skin. The electrolyte may be toxic if swallowed.
- Do not dispose of the batteries in a fire. Check with local waste management codes for special disposal instructions. To prevent fire or shock hazard, do not expose this product to water or any type of moisture.
- Observe proper polarity orientation between the battery and metallic contacts.
- Do not disassemble your headset. There are no user-serviceable parts inside. Refer to qualified service personnel for servicing.

### Precautions for users of implanted cardiac pacemakers

---

Cardiac pacemakers (applies only to **digital cordless devices**):

Wireless Technology Research, LLC (WTR), an independent research entity, led a multidisciplinary evaluation of the interference between portable **digital cordless devices and implanted cardiac pacemakers**. Supported by the U.S. Food and Drug Administration, WTR recommends to physicians that:

#### Pacemaker patients

---

- Should keep digital cordless devices at least six inches from the pacemaker.
- Should NOT place digital cordless devices directly over the pacemaker, such as in a breast pocket, when it is turned ON.
- Should use the digital cordless device at the ear opposite the pacemaker.

WTR's evaluation did not identify any risk to bystanders with pacemakers from other persons using **digital cordless devices**.

### **SAVE THESE INSTRUCTIONS**

## For C-UL compliance

In compliance with the bilingual requirements for safety, caution, and warning markings of Canadian Federal and Provincial/Territorial statutes and regulations, the French version of Important safety information is included.

### Mesures de sécurité importantes

---



Ce symbole vous alertera d'informations importantes ou d'instructions d'entretien pouvant apparaître dans ce guide d'utilisation. Respectez toujours les mesures de sécurité et de sécurité de base lorsque vous utilisez ce produit, afin de réduire les risques de blessures, d'incendie, ou d'électrocution.

### Information relative à la sécurité

---

- **Veillez lire et comprendre toutes les instructions de ce guide d'utilisation. Relectez toutes les inscriptions apparaissant sur le produit.**
- **Évitez d'utiliser le casque d'écoute pendant un orage.** Il pourrait y avoir un faible risque d'électrocution.
- **N'utilisez pas un casque d'écoute près d'une fuite de gaz.** Dans certaines circonstances, une flammèche pourrait se produire lorsque l'adaptateur est branché à une prise de courant, ou lorsque le casque d'écoute est déposé sur son chargeur. Ceci est un événement fréquent associé avec la fermeture d'un circuit électrique. L'utilisateur ne devrait pas brancher un téléphone dans une prise de courant, et ne devrait pas déposer un casque d'écoute chargé dans son chargeur, si le chargeur du casque d'écoute se trouve dans un environnement comportant une concentration de gaz inflammables ou ignifuges, à moins de se trouver dans un endroit où la ventilation est adéquate.
- **N'utilisez pas ce produit près de l'eau ou lorsque vous êtes mouillés.** Par exemple, ne l'utilisez pas dans des sous-sols humides ou sous la douche, ou près d'une piscine, d'un bain, d'un évier de cuisine, ou d'une cuve de lavage. N'utilisez pas de liquides, ou de vaporisateurs aérosol de nettoyage. Si le produit entre en contact avec du liquide, débranchez immédiatement le fil téléphonique ou le cordon d'alimentation. Ne rebranchez pas le produit avant qu'il soit complètement sec.
- **Installez cet appareil dans un endroit protégé** où personne ne peut trébucher sur les cordons d'alimentation ou la ligne téléphonique. Protégez les câbles contre les dommages ou l'abrasion.
- **Si le produit ne fonctionne pas correctement, consultez la section Dépannage (Troubleshooting) des pages 32-37 de ce guide d'utilisation.** Si vous ne pouvez pas régler le problème, ou si le produit est endommagé, consultez la section **Garantie limitée (Limited warranty)** des pages 52-54. N'ouvrez pas ce produit, sauf tel qu'indiqué dans le guide d'utilisation. L'ouverture du produit ou le remontage inadéquat pourrait vous exposer à des tensions dangereuses ou autres dangers.

## For C-UL compliance

- **Remplacez les piles uniquement tel que décrit dans votre guide d'utilisation (page 6).** N'incinérez pas et ne percez pas les piles — elles contiennent des produits chimiques caustiques.
- **L'adaptateur de courant est conçu pour être orienté verticalement ou installé sur le plancher.** Les broches ne sont pas conçues pour se maintenir en place si la fiche est branchée dans une prise de courant au plafond, sous la table ou sous une armoire.



### MISES EN GARDE:

- N'utilisez seulement l'adaptateur inclus avec ce produit. Pour obtenir une pièce de rechange, visitez notre site Web au **www.telephones.att.com/smb** ou composez le **1 (800) 222-3111**. Au Canada, composez le **1 (866) 288-4268**.
- N'utilisez que la pile de rechargeable incluse ou une pile de rechange (modèle BT191665). Pour commander, visitez notre site Web **www.telephones.att.com/smb** ou composez le **1 (800) 222-3111**. Au Canada, composez le **1 (866) 288-4268**.
- Afin de prévenir les risques d'incendie ou d'explosion de la pile, remplacez la pile avec une pile du même type. Jetez les piles épuisées en respectant les instructions.

### Spécifiquement en rapport avec casque d'écoute sans fil

---

- **Confidentialité:** Les mêmes caractéristiques qui rendent le casque d'écoute sans fil si pratique créent également des restrictions. Les appels téléphoniques sont transmis entre le socle du téléphone et le casque d'écoute par le biais d'ondes radio, et il se peut que vos conversations téléphoniques sur le casque d'écoute sans fil soient interceptées par d'autres équipements de réception d'ondes radio au sein de la portée du casque d'écoute sans fil. **Pour cette raison, vous ne devez pas considérer les conversations sur un téléphone sans fil comme étant aussi confidentielles que celles d'un téléphone à cordon.**
- **Alimentation électrique:** La base de ce casque d'écoute sans fil doit être branchée à une prise de courant électrique fonctionnelle. La prise électrique ne doit pas être contrôlée par un interrupteur mural. **Les appels ne peuvent pas être effectués à partir du socle du casque d'écoute n'est pas branchée, si elle est hors fonction ou si le courant électrique est coupé.**

## For C-UL compliance

- **Interférences potentielles aux téléviseurs:** Certains casques d'écoute sans fil fonctionnent sur des fréquences pouvant causer des interférences aux téléviseurs et magnétoscopes. Pour réduire ou prévenir de tels parasites, ne pas déposer le socle du téléphone à proximité d'un téléviseur ou magnétoscope, ni directement sur celui-ci. Si votre téléviseur affiche des interférences, éloignez le casque d'écoute sans fil de celui-ci afin de réduire les parasites.
- **Piles rechargeables:** Ce produit comporte des piles rechargeables au lithium-ion. Usez de prudence lorsque vous manipulez de telles piles et veillez à ne pas les court-circuiter avec des matériaux conducteurs, tels que des bagues, bracelets et clés. La pile ou le conducteur peut surchauffer et vous brûler. Respectez la polarité adéquate entre les piles et le chargeur de piles.
- **Piles rechargeables au lithium-ion:** Jetez ces piles de manière sécuritaire. N'incinerez pas et ne percez pas les piles. Comme pour les autres piles du même type, si elles sont brûlées ou percées, des matières corrosives peuvent s'en échapper, ce qui risque de causer des brûlures ou autres blessures corporelles.



Le sceau de l'organisme de recyclage RBRC<sup>MD</sup> sur les piles au lithium-ion signifie que le fabricant de cet appareil participe volontairement au programme industriel visant à reprendre et recycler ce type de piles lorsqu'elles ne servent plus, au sein du territoire des États-Unis et du Canada. Vous devez apporter ces piles chez un détaillant participant ou le centre de recyclage le plus près de chez vous. Ou vous pouvez composer le 1-800-8-BATTERY<sup>MD</sup> afin de connaître les endroits qui acceptent les piles au lithium-ion mortes.

RBRC<sup>MD</sup> et 1-800-8-BATTERY<sup>MD</sup> sont des marques déposées de Rechargeable Battery Recycling Corporation.

### MISES EN GARDE

- Il y a une faible risque d'explosion si vous utilisez le mauvais type de pile. N'utilisez que la pile rechargeable incluse ou conçue pour fonctionner avec votre appareil (modèle BT191665).
- Remplacez cette pile en respectant les instructions et les limitations spécifiées dans ce guide d'utilisation.
- Comme avec tout matériaux conducteur, veillez à ne pas court-circuiter les bornes de la pile avec des matériaux conducteurs, tels que des bagues, bracelets et clés. La pile ou le conducteur peut surchauffer et vous brûler. La pile ou les conducteurs peuvent surchauffer et causer des blessures.
- N'ouvrez pas et n'endommagez les piles. L'électrolyte qui s'en dégagerait est corrosif et peut causer des blessures aux yeux ou à la peau. L'électrolyte est toxique si avalé.

## For C-UL compliance

- N'incinerez pas les piles. Vérifiez auprès des autorités locales pour les instructions de mise aux rebus locales. Afin de prévenir les risques d'incendies, n'exposez pas ce produit à l'eau ou à l'humidité.
- Veuillez respecter la polarité des piles et des bornes métalliques.
- Ne démontez pas votre casque d'écoute. Aucune pièce pouvant être réparée par l'utilisateur ne se trouve à l'intérieur de l'appareil. Confiez la réparation à un technicien qualifié.

### **Mesures préventives pour les utilisateurs de stimulateurs cardiaques implantés dans l'organisme**

---

Stimulateurs cardiaques (ne s'applique qu'aux dispositifs numériques sans fil):

L'organisme 'Wireless Technology Research, LLC (WTR)', une firme de recherche indépendante, a mené une évaluation pluridisciplinaire des interférences entre les dispositifs numériques sans fil et les stimulateurs cardiaques implantés dans l'organisme. Appuyée par l'Administration des aliments et drogues (FDA) des États-unis, la firme WTR recommande aux médecins:

#### **Avis aux détenteurs de stimulateurs cardiaques**

---

- Ils doivent tenir les dispositifs numériques sans fil à une distance d'au moins six pouces du stimulateur cardiaque.
- Ils ne doivent PAS placer les dispositifs numériques sans fil directement sur le stimulateur cardiaque, tel que dans une poche de chemise, lorsque celui-ci est en fonction.
- Ils doivent utiliser les dispositifs numériques sans fil en les appuyant sur l'oreille qui se trouve dans la direction opposée au stimulateur cardiaque.

L'étude effectuée par l'organisme WRS n'a pas identifié de risque pour les détenteurs de simulateurs cardiaques causé par les gens qui utilisent des dispositifs numériques sans fil à proximité de ceux-ci.

### **CONSERVEZ CES INSTRUCTIONS**

## FCC Part 68 and ACTA

This equipment complies with Part 68 of the FCC rules and with technical requirements adopted by the Administrative Council for Terminal Attachments (ACTA). The label on the back or bottom of this equipment contains, among other things, a product identifier in the format US: AAAEQ##TXXXX. This identifier must be provided to your telephone service provider upon request.

The plug and jack used to connect this equipment to premises wiring and the telephone network must comply with applicable Part 68 rules and technical requirements adopted by ACTA. A compliant telephone cord and modular plug is provided with this product. It is designed to be connected to a compatible modular jack that is also compliant. An RJ11 jack should normally be used for connecting to a single line and an RJ14 jack for two lines. See the installation instructions in the user's manual.

The Ringer Equivalence Number (REN) is used to determine how many devices you may connect to your telephone line and still have them ring when you are called. The REN for this product is encoded as the 6th and 7th characters following the US: in the product identifier (e.g. if ## is 03, the REN is 0.3). In most, but not all areas, the sum of all RENs should be five (5.0) or less. For more information, please contact your telephone service provider.

This equipment may not be used with party lines. If you have specially wired alarm dialing equipment connected to your telephone line, ensure the connection of this equipment does not disable your alarm equipment. If you have questions about what will disable alarm equipment, consult your telephone service provider or a qualified installer.

If this equipment is malfunctioning, it must be unplugged from the modular jack until the problem has been corrected. Repairs to this telephone equipment can only be made by the manufacturer or its authorized agents. For repair procedures, follow the instructions outlined under the Limited warranty.

If this equipment is causing harm to the telephone network, the telephone service provider may temporarily discontinue your telephone service. The telephone service provider is required to notify you before interrupting service. If advance notice is not practical, you will be notified as soon as possible. You will be given the opportunity to correct the problem and the telephone service provider is required to inform you of your right to file a complaint with the FCC. Your telephone service provider may make changes in its facilities, equipment, operation, or procedures that could affect the proper functioning of this product. The telephone service provider is required to notify you if such changes are planned.

If this product is equipped with a corded or cordless handset, it is hearing aid compatible.



## FCC Part 68 and ACTA

If this product has memory dialing locations, you may choose to store emergency telephone numbers (e.g. police, fire, medical) in these locations. If you do store or test emergency numbers, please:

Remain on the line and briefly explain the reason for the call before hanging up.

Perform such activities in off-peak hours, such as early morning or late evening.

### **Industry Canada**

This device complies with Industry Canada licence-exempt RSS standard(s).

Operation is subject to the following two conditions: (1) this device may not cause harmful interference, and (2) this device must accept any interference received, including interference that may cause undesired operation.

Privacy of communications may not be ensured when using this telephone.

The term "IC:" before the certification/registration number only signifies that the Industry Canada technical specifications were met.

The Ringer Equivalence Number (REN) for this terminal equipment is 1.0. The REN is an indication of the maximum number of devices allowed to be connected to a telephone interface. The termination on an interface may consist of any combination of devices subject only to the requirement that the sum of the RENs of all the devices does not exceed five.

This product meets the applicable Industry Canada technical specifications.

## FCC Part 15

This equipment has been tested and found to comply with the requirements for a Class B digital device under Part 15 of the Federal Communications Commission (FCC) rules.

These requirements are intended to provide reasonable protection against harmful interference in a residential installation. This equipment generates, uses and can radiate radio frequency energy and, if not installed and used in accordance with the instructions, may cause harmful interference to radio communications. However, there is no guarantee that interference will not occur in a particular installation.

If this equipment does cause harmful interference to radio or television reception, which can be determined by turning the equipment off and on, the user is encouraged to try to correct the interference by one or more of the following measures:

- Reorient or relocate the receiving antenna.
- Increase the separation between the equipment and receiver.
- Connect the equipment into an outlet on a circuit different from that to which the receiver is connected.
- Consult the dealer or an experienced radio/TV technician for help.

Changes or modifications to this equipment not expressly approved by the party responsible for compliance could void the user's authority to operate the equipment.

This device complies with Part 15 of the FCC Rules. Operation is subject to the following two conditions: (1) this device may not cause harmful interference, and (2) this device must accept any interference received, including interference that may cause undesired operation. Privacy of communications may not be ensured when using this device.

To ensure safety of users, the FCC has established criteria for the amount of radio frequency energy that can be safely absorbed by a user or bystander according to the intended usage of the product. This product has been tested and found to comply with the FCC criteria. The headset may be safely held against the ear of the user. The telephone base shall be installed and used such that parts of the user's body other than the hands are maintained at a distance of approximately 20 cm (8 inches) or more.

This Class B digital apparatus complies with Canadian requirement:  
CAN ICES-3 (B)/NMB-3(B).

# California Energy Commission battery charging testing instructions

This telephone is set up to comply with the energy-conserving standards right out of the box. These instructions are intended for California Energy Commission (CEC) compliance testing only. When the CEC battery charging testing mode is activated, all headset functions, except battery charging, will be disabled.

If you have registered the cordless headset to the **TL7810/TL7812** headset base, below are the testing instructions.

## To activate the CEC battery charging testing mode:

1. Unplug the headset base power adapter from the power outlet. Make sure the headset is plugged with charged battery before proceeding.
2. Press and hold **PAIR** on the headset base while powering up the base by plugging in the adapter.
3. After about 20 seconds, when the **MUTE** light on the headset base starts flashing, release **PAIR** and then press it again within two seconds.



The process takes up to one minute to complete. When the headset successfully enters the CEC battery charging testing mode, the  light flashes slowly in red and blue.

**Note:** When the headset fails to enter this mode, repeat all the steps mentioned above.

## To deactivate the CEC battery charging testing mode:

1. Unplug the headset base power adapter from the power outlet, then plug it back in. The headset base is powered up as normal.
2. Register the headset back to the headset base. See page 9 for headset registration instructions.

If you have registered the cordless headset to a compatible AT&T DECT cordless telephone, please refer to the respective user's manual for the activation and deactivation of CEC battery charging testing mode.



# California Energy Commission battery charging testing instructions

If you have registered the cordless headset to the **Synapse SB67030/SB67031** deskset, below are the testing instructions. When the CEC battery charging testing mode is activated, all headset functions, except battery charging, will be disabled.

## To activate the CEC battery charging testing mode:

1. Press **MENU** on the deskset in idle mode.
2. Scroll to **User Settings**, then press **SELECT**.
3. Scroll to **Cordless Settings**, then press **SELECT**.
4. Scroll to **Headset**, then press **SELECT**. The screen shows **Cordless Headset is currently Registered**.
5. On the deskset, press **DeReg**. The screen displays **Are you sure you want to deregister the Cordless Headset?**
6. Press **Yes** to confirm.



The process takes up to 10 seconds to complete. When the headset successfully enters the CEC battery charging testing mode, the screen displays **Cordless Handset is currently Not registered** and the headset  light flashes slowly in red and blue.

**Note:** When the headset fails to enter this mode, repeat all the steps mentioned above.

## To deactivate the CEC battery charging testing mode:

1. Unplug the deskset power adapter from the power outlet, then plug it back in. The deskset is powered up as normal.
2. Register the cordless headset back to the deskset. See page 10 for headset registration instructions.

# California Energy Commission battery charging testing instructions

If you have registered the cordless headset to the **SynJ SB67138/SB67158** base, below are the testing instructions. When the CEC battery charging testing mode is activated, all headset functions, except battery charging, will be disabled.

## To activate the CEC battery charging testing mode:

1. Press **MENU/ENTER** on the telephone base in idle mode.
2. Scroll down to **Registration** and press **MENU/ENTER**.
3. Scroll down to **Deregistration** and then press **MENU/ENTER**.
4. The telephone base screen shows **Deregister:**. Scroll to choose the **TL7800** headset, then press **MENU/ENTER**.
5. The telephone base screen prompts if you want to deregister the headset. Press **◀REP** to exit or press **SKIP▶** to continue.
6. If you press **SKIP▶**, the telephone base shows **Deregistering**.



The process takes up to 10 seconds to complete. When the headset successfully enters the CEC battery charging testing mode, the headset  light flashes slowly in red and blue. The telephone base shows **Headset X deregistered** and beeps.

**Note:** When the headset fails to enter this mode, repeat all the steps mentioned above.

## To deactivate the CEC battery charging testing mode:

1. Unplug the telephone base power adapter from the power outlet, then plug it back in. The telephone base is powered up as normal.
2. Register the cordless headset back to the telephone base. See pages 11-12 for headset registration instructions.

## Limited warranty

The AT&T brand is used under license - any repair, replacement or warranty service, and all questions about this product should be directed to: In the United States of America, visit **[www.telephones.att.com/smb](http://www.telephones.att.com/smb)** or call **1 (800) 222-3111**. In Canada, call **1 (866) 288-4268**.

### 1. What does this limited warranty cover?

The manufacturer of this AT&T branded product warrants to the holder of a valid proof of purchase (“CONSUMER” or “you”) that the product and all accessories provided in the sales package (“PRODUCT”) are free from defects in material and workmanship, pursuant to the following terms and conditions, when installed and used normally and in accordance with the PRODUCT operating instructions. This limited warranty extends only to the CONSUMER for products purchased and used in the United States of America and Canada.

### 2. What will be done if the PRODUCT is not free from defects in materials and workmanship during the limited warranty period (“materially defective PRODUCT”)?

During the limited warranty period, the manufacturer’s authorized service representative will repair or replace at the manufacturer’s option, without charge, a materially defective PRODUCT. If the manufacturer repairs the PRODUCT, they may use new or refurbished replacement parts. If the manufacturer chooses to replace the PRODUCT, they may replace it with a new or refurbished PRODUCT of the same or similar design. The manufacturer will retain defective parts, modules, or equipment. Repair or replacement of the PRODUCT, at the manufacturer’s option, is your exclusive remedy. The manufacturer will return repaired or replacement products to you in working condition. You should expect the repair or replacement to take approximately 30 days.

### 3. How long is the limited warranty period?

The limited warranty period for the PRODUCT extends for ONE (1) YEAR from the date of purchase. If the manufacturer repairs or replaces a materially defective PRODUCT under the terms of this limited warranty, this limited warranty also applies to repaired or replacement PRODUCT for a period of either (a) 90 days from the date the repaired or replacement PRODUCT is shipped to you or, (b) the time remaining on the original one-year limited warranty; whichever is longer.

## Limited warranty

### 4. What is not covered by this limited warranty?

This limited warranty does not cover:

- PRODUCT that has been subjected to misuse, accident, shipping or other physical damage, improper installation, abnormal operation or handling, neglect, inundation, fire, water, or other liquid intrusion; or
- PRODUCT that has been damaged due to repair, alteration, or modification by anyone other than an authorized service representative of the manufacturer; or
- PRODUCT to the extent that the problem experienced is caused by signal conditions, network reliability or cable or antenna systems; or
- PRODUCT to the extent that the problem is caused by use with non-AT&T accessories; or
- PRODUCT whose warranty/quality stickers, PRODUCT serial number plates or electronic serial numbers have been removed, altered or rendered illegible; or
- PRODUCT purchased, used, serviced, or shipped for repair from outside the United States of America or Canada, or used for commercial or institutional purposes (including but not limited to products used for rental purposes); or
- PRODUCT returned without a valid proof of purchase (see item 6); or
- Charges for installation or setup, adjustment of customer controls, and installation or repair of systems outside the unit.

### 5. How do you get warranty service?

To obtain warranty service in the United States of America, visit

**[www.telephones.att.com/smb](http://www.telephones.att.com/smb)** or call

**1 (800) 222-3111**. In Canada, call **1 (866) 288-4268**.

NOTE: Before calling for service, please review the user's manual; a check of the PRODUCT's controls and features may save you a service call.

Except as provided by applicable law, you assume the risk of loss or damage during transit and transportation and are responsible for delivery or handling charges incurred in the transport of the PRODUCT(s) to the service location. The manufacturer will return repaired or replaced PRODUCT under this limited warranty to you. Transportation, delivery or handling charges are prepaid. The manufacturer assumes no risk for damage or loss of the PRODUCT in transit. If the PRODUCT failure is not covered by this limited warranty, or proof of purchase does not meet the terms of this limited warranty, the manufacturer will notify you and will request that you authorize the cost of repair prior to any further repair activity. You must pay for the cost of repair and return shipping costs for the repair of products that are not covered by this limited warranty.

## Limited warranty

### 6. What must you return with the PRODUCT to get warranty service?

You must:

- a. Return the entire original package and contents including the PRODUCT to the service location along with a description of the malfunction or difficulty; and
- b. Include a “valid proof of purchase” (sales receipt) identifying the PRODUCT purchased (PRODUCT model) and the date of purchase or receipt; and
- c. Provide your name, complete and correct mailing address, and telephone number.

### 7. Other limitations

This warranty is the complete and exclusive agreement between you and the manufacturer of this AT&T branded PRODUCT. It supersedes all other written or oral communications related to this PRODUCT. The manufacturer provides no other warranties for this PRODUCT. The warranty exclusively describes all of the manufacturer’s responsibilities regarding the PRODUCT. There are no other express warranties. No one is authorized to make modifications to this limited warranty and you should not rely on any such modification.

State/Provincial Law rights: This warranty gives you specific legal rights, and you may also have other rights which vary from state to state or province to province.

Limitations: Implied warranties, including those of fitness for a particular purpose and merchantability (an unwritten warranty that the PRODUCT is fit for ordinary use) are limited to one year from date of purchase. Some states/provinces do not allow limitations on how long an implied warranty lasts, so the above limitation may not apply to you. In no event shall the manufacturer be liable for any indirect, special, incidental, consequential, or similar damages (including, but not limited to lost profits or revenue, inability to use the PRODUCT or other associated equipment, the cost of substitute equipment, and claims by third parties) resulting from the use of this PRODUCT. Some states/provinces do not allow the exclusion or limitation of incidental or consequential damages, so the above limitation or exclusion may not apply to you.

**Please retain your original sales receipt as proof of purchase.**



## Technical specifications

RF frequency band	1921.536MHz - 1928.448MHz
Channels	5
Operating temperature	32°F - 122°F 0°C - 50°C
Headset voltage	3.2VDC - 4.2VDC
Charger voltage (AC adapter output)	6VDC @400mA
Replacement battery	3.7V 240mAH

### DECT 6.0 digital technology

Digital Enhanced Cordless Telecommunications (DECT) 6.0 is a new frequency band that transmits your voice across multiple channels. This technology provides superior quality of voice and sound, high protection against wiretapping and better range than 2.4 GHz and 5.8 GHz phone systems, while not interfering with wireless routers.

### Operating range

This cordless headset operates within the maximum power allowed by the Federal Communications Commission (FCC). Even so, this headset and headset base can communicate over a certain distance — which can vary with the locations of the headset base and headset, the weather, and the construction of your home or office.

### Extended range and clarity

Experience the best in long-range coverage and clarity, provided by a unique antenna design and advances in noise-filtering technology. The TL7800 is a fully cordless DECT 6.0 headset offering a range of up to 500 feet. Open range test was performed by Wyle Laboratories, an independent commercial test facility. “Up to 500 feet” cordless headset range refers to the maximum open field range. Actual range may vary depending on intervening obstacles.

Sound level protection technology conforms to the current regulations and is used to filter out the loud and high-pitched noises.

# Index

## A

---

- AC adapter 7, 55
- Alert tone 3
- Answer a call 28

## B

---

- Battery charging 7
- Battery installation 6
- Behind the neck band 25–27

## C

---

- Call waiting 29
- Charging cradle 4

## D

---

- Deregister all headsets 15–18

## E

---

- Earbud 19
- Ear hook 20–22
- End a call 28

## H

---

- Head band 23–24
- Headset
  - alert tones 3
  - attachments 19–27
  - lights 1
  - operation 28–31
  - registration 8–14

## I

---

- Installation
  - battery 6
  - charger 7

## L

---

- Lights 1
- Limited warranty 52–54
- Listening volume 30

## M

---

- Magnetic charging mount 4
- Maintenance 38
- Make a call 28
- Multiple headsets use 31
- Mute 30

## N

---

- Neck band 25–27

## O

---

- Over the ear hook 20–22
- Over the head band 23–24

## P

---

- Power off 28
- Power on 28

# Index

## Q

---

Quick reference guide

headset 1–3

headset charger 4

## R

---

Register a headset 8–14

Ringer 29

## T

---

Technical specifications 55

Temporary ringer silencing 29

Troubleshooting 32–37

## V

---

Volume control

listening volume 30

ringer 29



**[www.telephones.att.com/smb](http://www.telephones.att.com/smb)**

© 2012-2016 Advanced American Telephones. All Rights Reserved.

AT&T and the AT&T logo are trademarks of AT&T Intellectual Property licensed to  
Advanced American Telephones, San Antonio, TX 78219.

Synapse® and SynJ® are registered trademarks of Advanced American Telephones.

RBRC® and 1-800-8-BATTERY® are registered trademarks of the  
Rechargeable Battery Recycling Corporation.

Printed in China. Issue 6.0 AT&T 03/16.