



at&t



Proud Sponsor

User's manual

**EL42208/EL42308/EL42408/  
EL42258**

**5.8 GHz cordless telephone/  
answering system with  
caller ID/call waiting**



# Congratulations

on purchasing your  
new AT&T product.

Before using this AT&T product, please  
read the **Important safety instructions**  
on pages 52-54 of this manual.

Please thoroughly read the user's  
manual for all the feature operations  
and troubleshooting information necessary to install  
and operate your new  
AT&T product. You can also visit our  
website at **www.telephones.att.com**  
or call **1 (800) 222-3111**.  
In Canada, dial **1 (866) 288-4268**.

Model #: EL42208/EL42308/EL42408/EL42258  
Type: 5.8GHz cordless telephone/answering system  
Serial #: \_\_\_\_\_  
(found on the bottom of the telephone base)  
Purchase date: \_\_\_\_\_  
Place of purchase: \_\_\_\_\_

Both the model and serial number of your AT&T product can be found on the  
bottom of the telephone base.



The ENERGY STAR<sup>®</sup> program ([www.energystar.gov](http://www.energystar.gov)) recognizes and encourages the use of products that save energy and help protect our environment. We are proud to mark this product with the ENERGY STAR<sup>®</sup> label indicating it meets the latest energy efficiency guidelines.

You must install and charge the battery before using the telephone.



See page 9  
for easy instructions.

If you subscribe to high-speed Internet service (Digital Subscriber Line - DSL) through your telephone lines, you must install a DSL filter between the telephone base and the telephone wall jack (page 6). The filter will prevent noise and caller ID problems caused by DSL interference. Please contact your DSL service provider for more information about DSL filters.

Your product may be shipped with a protective sticker covering the handset or base display - remove it before use.

For customer service or product information, visit our website at **www.telephones.att.com** or call **1 (800) 222-3111**. In Canada, dial **1 (866) 288-4268**.



**CAUTION:** To reduce the risk of fire or injury to persons or damage to the telephone, read and follow these instructions carefully:

- Use only the supplied rechargeable battery or replacement battery (part number 89-1332-00-00) or equivalent. To order a replacement battery, visit our website at **www.telephones.att.com** or call **1 (800) 222-3111**. In Canada, dial **1 (866) 288-4268**.
- Do not dispose of the battery in a fire. Like other batteries of this type, it could explode if burned. Check with local codes for special disposal instructions.
- Do not open or mutilate the battery. Released electrolyte is corrosive and may cause damage to the eyes or skin. It may be toxic if swallowed.
- Exercise care in handling batteries in order not to create a short circuit. Do not allow conductive materials such as rings, bracelets, or keys to touch the battery. The battery or conductor may overheat and cause harm.
- Charge the battery provided with or identified for use with this product only in accordance with the instructions and limitations specified in this manual.
- Observe proper polarity orientation between the battery and battery charger.
- Do not disassemble your telephone. There are no user-serviceable parts inside. Refer to qualified service personnel for servicing.

# Parts checklist

Save your sales receipt and original packaging in the event warranty service is necessary.

Your telephone contains the following items:

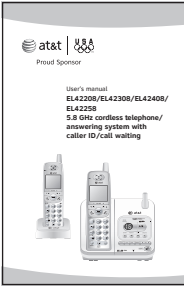

User's manual



Quick start guide



Cordless handset  
(2 for EL42208)  
(2 for EL42258)  
(3 for EL42308)  
(4 for EL42408)



Telephone base



Battery for cordless handset  
(2 for EL42208)  
(2 for EL42258)  
(3 for EL42308)  
(4 for EL42408)



Charger for cordless handset with power adapter installed  
(1 for EL42208)  
(1 for EL42258)  
(2 for EL42308)  
(3 for EL42408)



Battery compartment cover  
(2 for EL42208)  
(2 for EL42258)  
(3 for EL42308)  
(4 for EL42408)



Power adapter for telephone base

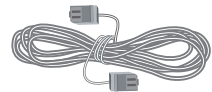

Telephone line cord

# User's manual

## EL42208/EL42308/EL42408/ EL42258

### 5.8 GHz cordless telephone/ answering system with caller ID/call waiting



## Table of contents

### Getting started

Quick reference guide	
handset.....	2
telephone base.....	3
Handset main menu.....	4
Telephone base & charger	
installation.....	5
Installation options.....	7
Battery installation & charging....	9

### Telephone operation

Settings.....	11
Basic operation.....	14
Options while on calls.....	17
Call transfer for	
EL42208/EL42258.....	18
Call transfer for EL42308.....	19
Call transfer for EL42408.....	20

### Directory

Directory.....	21
Speed dial.....	22
New directory entries.....	23
Directory search.....	25
Change or dial entries.....	26

### Caller ID operation

Caller ID history.....	27
Review the call history.....	30
Delete call history entries.....	31
Add entries to the directory.....	32

### Answering system

Answering system.....	33
Day & time announcements.....	34
Outgoing announcements.....	35
Changing feature options.....	36
Message playback.....	37
Record & play memos.....	38
Message counter displays.....	39
Answering system mode.....	40
Remote access.....	41

### Appendix

Screen icons, indicator lights	
& tones.....	42
Handset display screen	
messages.....	43
Troubleshooting.....	45
Important safety instructions.....	52
FCC part 68 & ACTA.....	55
FCC part 15.....	57
Limited warranty.....	58
Technical specifications.....	61
Index.....	62

# Quick reference guide - handset

## CHARGE

The light is on when a cordless handset is properly positioned to charge in the telephone base or charger.

## ▼CID/-VOLUME

When in a menu, press to scroll down. When the phone is not in use, press to display call history entries (page 30). While entering names or numbers, press to move the cursor to the left. During a call, press to decrease listening volume.

## PHONE/FLASH

Press to make or answer a call. During a call, press to receive an incoming call if call waiting is activated (page 17).

## CHAN/REMOVE

When on a call, press to scan for a clearer channel when there is static or interference on the line (page 17). When the phone is not in use, press to delete the displayed caller ID entry (page 31), or press and hold to delete all caller ID entries when the phone is not in use (page 31).

## MENU/SEL/TRANSFER

Press to display menu. Press to store a programming option. During a call, press to transfer a call between handsets (pages 18-20).

## DIR ▲/VOLUME+

When in a menu, press to scroll up. When the phone is not in use, press to display directory entries (page 25). While entering names, press to advance the cursor. During a call, press to increase listening volume.

## OFF/CLEAR

During a call, press to hang up (page 14). While using menus, press to cancel an operation, or exit the menu.

## REDIAL/PAUSE

When the phone is not in use, Press repeatedly to display the last five numbers called (page 15). While dialing or entering numbers to the directory, press to insert a four-second dialing pause (page 24).

## MUTE

While on a call, press to mute the microphone. Press again to resume your conversation (page 17).

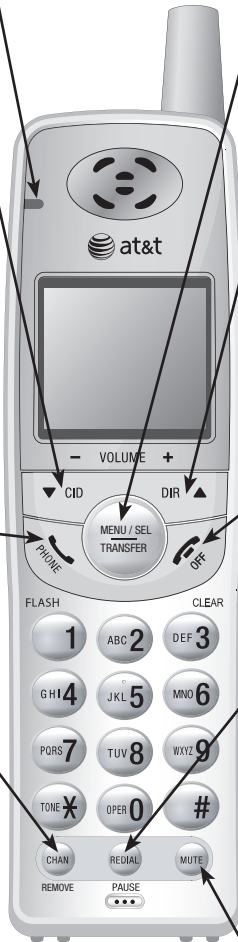

# Quick reference guide - telephone base



## IN USE

- On steady when a handset is in use.
- Flashes quickly while an incoming call is ringing.

## HANDSET LOCATOR

Press to make the handset beep when a handset is not on the telephone base (page 16).

## Answering System Functions

### MESSAGE COUNTER

Number of messages (or during playback, message number currently playing).

### ◀REPEAT

Press to repeat message; press **twice** to play previous message (page 37).

### ⏻ ON/OFF

Press to turn answering system on or off (page 40).

### CLOCK

Press to review or set clock (page 34).

### SETUP

Press to review or change answering system options (page 36).

### ANNC.

Press to review or record announcement; press again to quit (page 35).

### ▶/■ PLAY/STOP

Press to start or stop message playback (page 37).

### ▶▶SKIP

Press to skip message (page 37).

### ✕DELETE

Press to delete message currently playing; press twice to delete all old messages while the phone is not in use (page 37).

### ↕VOL

Press to adjust playback volume (page 37).

### RECORD

Press to record a memo (page 38) or after pressing **ANNC.** to record an outgoing announcement (page 35).

## Handset main menu

To enter the main menu:

1. Press **MENU/SEL** when the handset is not in use.
2. Press **▼CID** or **DIR▲** to select a handset feature menu, then press **MENU/SEL** to enter that menu.

To return to the idle mode, press **⏏OFF/CLEAR**.

**DIRECTORY** allows you to store and search for names and numbers (page 21).



**SPEED DIAL** allows you to store or dial a number in a speed dial location (page 22).

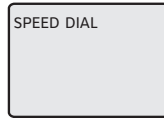

**RINGER** allows you to set the ringer (page 12).

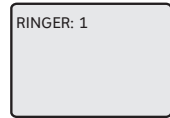

**RINGER VOL** allows you to set the ringer volume (page 12).

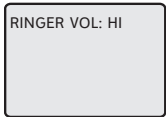

**DATE/TIME** allows you to set the date and time (page 13).

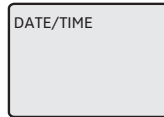

**DIAL MODE** allows you to set tone or pulse dialing (page 11).

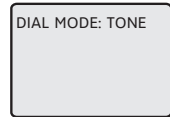

**HOME AREA CODE** allows you to set your home area code (page 13).

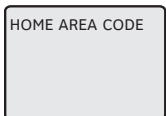

**LANGUAGE** allows you to set your handset display language (page 11).

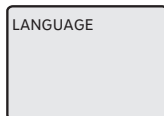



## Telephone base & charger installation

The telephone base can be placed on a flat surface or vertically mounted on the wall (page 7). For optimum range and better reception, place the telephone base in a central and open location.

### **Avoid placing the telephone base too close to:**

- Communication devices such as: personal computers, computer routers, television sets, VCRs, wireless routers (wireless broadband, wi-fi, or 802.11) or other cordless telephones.
- Excessive heat sources.
- Noise sources such as a window with traffic outside, motors, microwave ovens, refrigerators, or fluorescent lighting.
- Excessive dust sources such as a workshop or garage.
- Excessive moisture.
- Extremely low temperature.
- Mechanical vibration or shock such as on top of the washing machine or work bench.

## Telephone base & charger installation

If you subscribe to high-speed Internet service (Digital Subscriber Line - DSL) through your telephone lines, you must install a DSL filter between the telephone base and the telephone wall jack. The filter will prevent noise and caller ID problems caused by DSL interference. Please contact your DSL service provider for more information about DSL filters.

Install the telephone base and charger as shown below.

### Telephone base installation

1. Plug the small end of the power adapter into the power jack on the underside of the telephone base.

2. Plug one end of the telephone line cord into the telephone jack on the underside of the telephone base.

5. Plug the large end of the power adapter into an electrical outlet not connected to a wall switch.

3. Route cords through slots.

4. Plug the other end of the telephone line cord into a telephone jack.

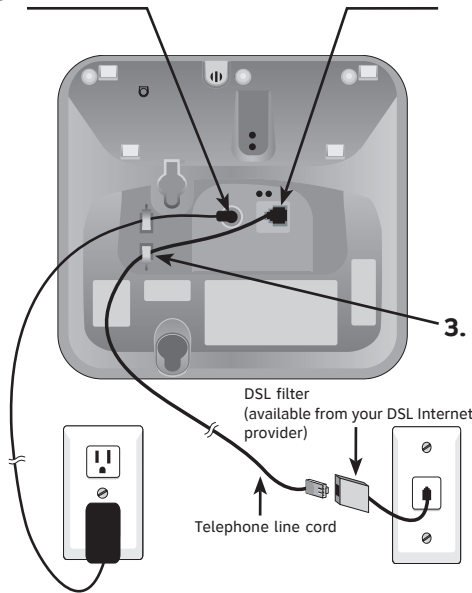

### Charger installation

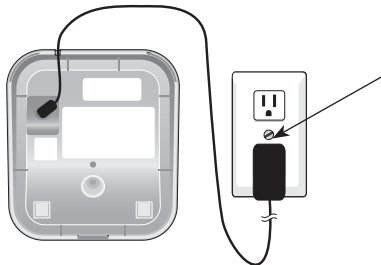

Plug the power adapter into an electrical outlet not connected to a wall switch.



#### NOTES:

1. Use only the supplied rechargeable battery, replacement battery (part number 89-1332-00-00) or equivalent. To order a replacement battery, visit our website at [www.telephones.att.com](http://www.telephones.att.com) or call **1 (800) 222-3111**. In Canada, dial **1 (866) 288-4268**.
2. This power adapter is intended to be correctly oriented in a vertical or floor mount position. The prongs are not designed to hold the plug in place if it is plugged into a ceiling, under-the-table or cabinet outlet.

## Installation options

The telephone base is designed for both desktop installation and wall mount installation. If wall mounting is desired, a telephone outlet wall mounting plate with mounting studs is required. This mounting plate is available for purchase at many hardware or consumer electronics retailers and may require professional installation.

### **Desktop to wall mount installation**

---

1. Plug the telephone line cord and power adapter into the telephone base. Bundle the telephone line cord and route cords through the slots, then secure with a twist tie.



2. Plug the power adapter and telephone line cord into the wall outlets, then align the mounting studs on the telephone outlet plate with the mounting holes on the telephone base.

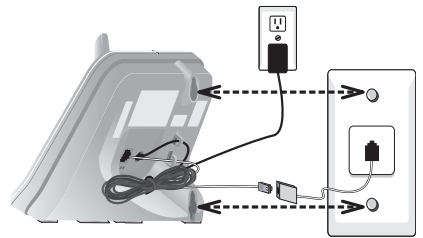

3. Place the telephone base mounting holes just above the mounting studs, then slide the telephone base down until it is secure.

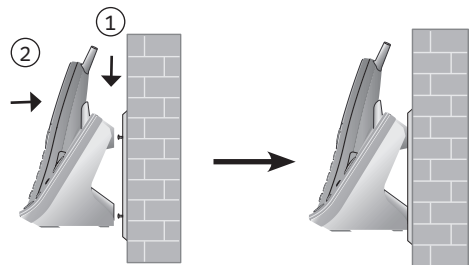

## Installation options

### Wall mount to desktop installation

---

To change the telephone base from the wall mount position to desktop position, make sure that you first unplug the power adapter and telephone line cord from the wall outlets before you begin.

1. Slide the telephone base upwards, then pull the telephone base away from the wall off of the mounting studs.

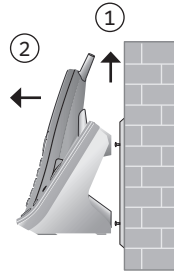

2. Unplug the power adapter and the telephone line cord from the electrical outlet and the telephone jack.

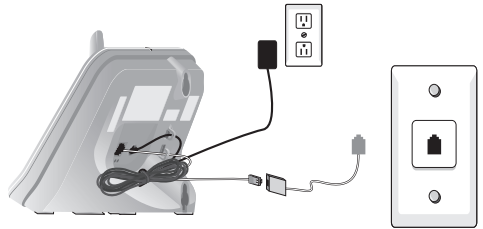

3. Plug the telephone line cord into the telephone base and telephone wall jack, then plug the power adapter plug into the telephone base and a power outlet not connected to a wall switch.

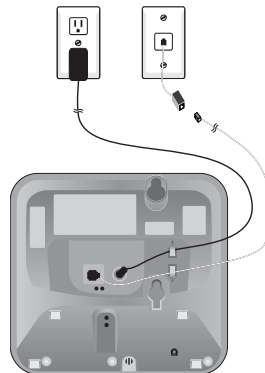

## Battery installation & charging

Install the battery as shown below. After installing the battery, you can make and receive short calls, but replace the handset in the telephone base or charger when not in use. For optimal performance, charge the handset battery for at least 16 hours before use. When fully charged, the handset battery provides approximately five hours of talk time or six days of standby time. If the handset has not been used for a long time or if the battery inside is completely depleted, put it on the telephone base or charger for recharging.

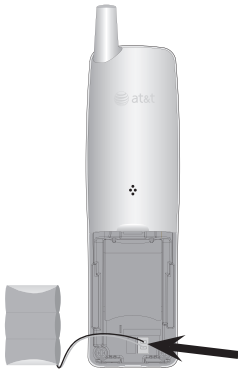

### Step 1

Insert the battery plug as indicated, making sure that it matches the color-coded label inside the battery compartment.



### Step 2

Place the battery and wires inside the compartment.



### Step 3

Slide the battery compartment cover up until it clicks.

### Step 4

Charge the handset, by placing the handset face up in the telephone base. The **CHARGE** light on the handset should be on as soon as the handset is properly placed on the telephone base.

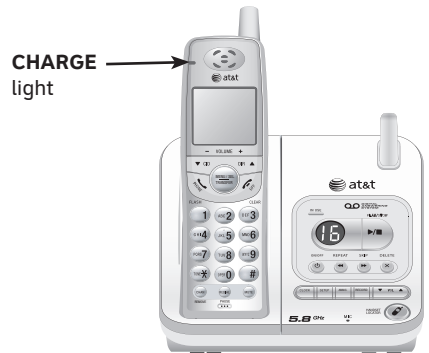

## Battery installation & charging

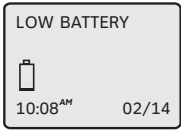

### Low battery indicator

Return the handset to the telephone base or charger to recharge when this symbol flashes and the handset beeps or when the handset screen displays **LOW BATTERY**.



To replace the battery, press the tab and slide the battery compartment cover downwards. Lift out the old battery and disconnect it from the handset. Follow the instructions on the previous page to install and charge the new battery.

### IMPORTANT INFORMATION

Use only the supplied rechargeable battery, replacement battery (part number 89-1332-00-00) or equivalent. To order a replacement battery, visit our website at

**[www.telephones.att.com](http://www.telephones.att.com)** or call **1 (800) 222-3111**. In Canada, dial **1 (866) 288-4268**.

## Settings

Each cordless handset operates independently from the other handsets. The ringer sound, ringer volume, date and time, dial mode, home area code and language must be programmed separately for each cordless handset.

To customize how the handset works:

1. Press **MENU/SEL** in the idle mode to enter the handset main menu.
2. Use **▼CID** or **DIR ▲** to scroll to the desired feature.
3. Press **MENU/SEL** to select the feature.

To stop at any time, press **OFF/CLEAR**.

### Language

---

To change the language to Espanol, or Francais:

1. Press **MENU/SEL** in the idle mode to enter the handset main menu.
2. Press **▼CID** or **DIR ▲** until the screen displays **LANGUAGE**.
3. Press **MENU/SEL**. The current setting is flashing.
4. Press **▼CID** or **DIR ▲** to choose **ENGLISH**, **FRANCAIS**, or **ESPAÑOL**.
5. Press **MENU/SEL** to save your selection and return to the main menu.

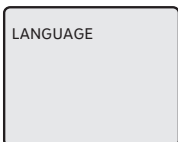

### Dial mode

---

The dial mode defaults to tone. If you do not have touch tone service, you will need to change the setting to pulse:

1. Press **MENU/SEL** in the idle mode to enter the handset main menu.
2. Press **▼CID** or **DIR ▲** until the screen displays **DIAL MODE:** and the current setting.
3. Press **MENU/SEL**. The current setting is flashing.
4. Press **▼CID** or **DIR ▲** to display **TONE** or **PULSE**.
5. Press **MENU/SEL** to save your selection and return to the main menu.

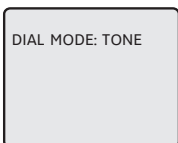

## Settings

### Ringer volume

---

You can set your handset to a ring volume level of **HI**, **LOW**, or **OFF**. To set the ring level:

1. Press **MENU/SEL** in the idle mode to enter the handset main menu.
2. Press **▼CID** or **DIR ▲** until the screen displays **RINGER VOL:** and the current setting.
3. Press **MENU/SEL**. The current setting is flashing. You also hear the current volume level.
4. Press **▼CID** or **DIR ▲** to choose the desired volume level. You will hear a sample of each ringer volume.
5. Press **MENU/SEL** to save your selection and return to the main menu.

#### -OR-

1. Press and hold **▼CID** or **DIR ▲** when the cordless handset is idle (not in use).
2. Press **▼CID** or **DIR ▲** to choose the desired volume level. You will hear a sample of each ringer volume.
3. Press **MENU/SEL** to save your selection and return to the main menu.

### Ringer

---

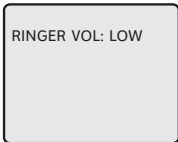

1. Press **MENU/SEL** in the idle mode to enter the handset main menu.
2. Press **▼CID** or **DIR ▲** until the screen displays **RINGER:** and the current setting.
3. Press **MENU/SEL**. The current setting is flashing. You also hear the current ringer sound.
4. Press **▼CID** or **DIR ▲** to display **1**, **2**, **3** or **4**. You will hear a sample of each ringer sound.
5. Press **MENU/SEL** to choose the displayed ringer sound and return to the main menu.



RINGER VOL: LOW



#### NOTES:

1. If you choose **OFF**, the cordless handset ringer will be turned off, and the screen will display **RINGER OFF** and  when the cordless handset is idle (not in use). If there are unreviewed calls, the screen will display **XX MISSED CALLS** and  instead of **RINGER OFF** and .
2. When the volume level is at the **HI** or **OFF** setting, you will hear two alert beeps.



RINGER: 1



## Settings

### Date & time

---

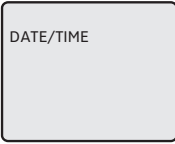

**NOTES:**

1. You can choose to set the time manually, or you can allow it to be set automatically with incoming caller ID information. The time will be set automatically only if you subscribe to caller ID service provided by your local telephone company (page 27). The date and time for the answering machine need to be set separately (page 34).
2. Caller ID will not set the year. See page 34 for instructions on how to set the year.

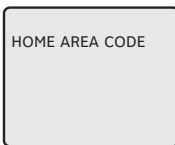

**NOTE:** If, in the future, your telephone service provider requires you to dial 10 digits to make a local call (area code + phone number), program your home area code to **000**.

To manually set the date and time on the handset display:

1. Press **MENU/SEL** in the idle mode to enter the handset main menu.
2. Press **▼CID** or **DIR ▲** until the screen displays **DATE/TIME**.
3. Press **MENU/SEL** to view or set date and time.
4. Press **▼CID** or **DIR ▲** to change the month in the date and time line at the bottom of the display, then press **MENU/SEL**.
5. Repeat step four to set the date, hour, minute, and AM/PM.
6. Press **MENU/SEL** to save selection and return to the main menu.

### Home area code

---

If you dial seven digits to make a local call (area code not required), you can program your area code into the telephone as the home area code. After setting, if you receive a call from within your home area code, the screen will display the telephone number with the home area code. However, the home area code will not be shown when reviewing the caller ID history.

To program the home area code:

1. Press **MENU/SEL** in the idle mode to enter the handset main menu.
2. Press **▼CID** or **DIR ▲** until the screen displays **HOME AREA CODE**.
3. Press **MENU/SEL**.
4. Press the dial pad keys to enter a three-digit home area code.
5. Press **MENU/SEL** to save and return to the main menu.

Please refer page 30 for other dialing options.

## Basic operation

### Make & end a call

---

To make a call:

- Press **PHONE/FLASH**, then enter the telephone number.

To end a call:

- Press **OFF/CLEAR** or return the handset in the telephone base or charger.

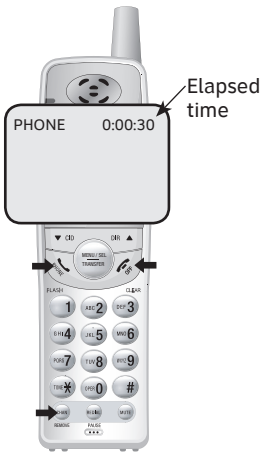

### On-hook dialing (predialing)

---

- Enter the telephone number, then press **PHONE/FLASH**. To make corrections as you enter the number, press **▼CID** or **DIR▲** to move to the digit you want to erase, then press **CHAN/REMOVE**.

The screen displays the elapsed time of the current call (in hours, minutes and seconds).

### Answer a call

---

To answer a call:

- Press **PHONE/FLASH**.

**-OR-**

- Press any keys (except **▼CID**, **DIR▲** and **OFF/CLEAR**).

To end a call:

- Press **OFF/CLEAR** or return the handset in the telephone base or charger.



#### NOTES:

1. Only one cordless handset can be on a call at a time. When one of the handsets is in use, the other handset(s) screen displays **SYSTEM HS BUSY**.
2. Pressing **PHONE/FLASH** to access service from your local telephone service provider will not affect the elapsed time.

## Basic operation



### Redial

---

While the phone is not in use, press **REDIAL/PAUSE** repeatedly to display the last five numbers called (up to 30 digits). To dial the number displayed, press **PHONE/FLASH**. Or, after pressing **PHONE/FLASH**, press **REDIAL/PAUSE** to call the number last dialed.

To delete the redial memory, press **REDIAL/PAUSE**, then press **CHAN/REMOVE** to delete one by one.

Press **OFF/CLEAR** to exit.



**NOTE:** While on a call, press **REDIAL/PAUSE** to review the last number dialed. You cannot delete from redial while on a call.

### Temporary ringer silencing

---

While the telephone is ringing, press **OFF/CLEAR** to silence the ringer temporarily. This will silence the ringer without disconnecting the call. You can answer the call or let the caller leave a message. The next incoming call will ring normally.

### Auto off

---

A call will be ended automatically when you put the handset in the telephone base or charger.

## Basic operation

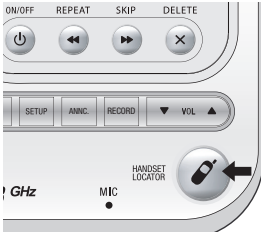

### Handset locator

The handset locator feature is useful if you misplace a handset(s).

To start the paging tone:

- Press  **HANDSET LOCATOR** at the telephone base. This starts the paging tone at the handsets for 60 seconds to help you locate the handsets.



**NOTE:** If one of the cordless handsets is charging in the base, pressing  **HANDSET LOCATOR** does not generate a paging tone.

To stop the paging tone:

- Press  **HANDSET LOCATOR** on the telephone base.
- OR-**
- Place one of the cordless handsets in the telephone base.



**NOTE:** When paging, pressing  **OFF/CLEAR** on any cordless handset will cancel the page of that specific handset. The handset locator feature will not be cancelled.

## Options while on calls



### Volume control

---

While on a call, press **▼CID/-VOLUME** to decrease the volume, press **DIR▲/VOLUME+** to increase the volume.

### Call waiting

---

If you subscribe to call waiting service with your local telephone company, there will be a beep if there is an incoming call while you are already on a call. Press **PHONE/FLASH** to put your current call on hold and take the new call. Press **PHONE/FLASH** anytime to switch back and forth between calls.

### Mute

---

The mute function allows you to silence the microphone. You can hear the caller, but the caller will not be able to hear you.

To mute the call:

- Press **MUTE** to silence the microphone. When mute is on, **MIC MUTED** will display temporarily on the handset screen and **MUTE** will be shown until mute is turned off.

To un-mute the call:

- Press **MUTE** again and resume speaking. When mute is turned off, **MIC ON** will display temporarily on the handset screen.



### Temporary tone dialing

---

If dial pulse (rotary) is selected, you can switch to touch tone dialing during a call by pressing **TONE\***. This can be useful if it is necessary to send tone signals for access to answering systems or long-distance services.

After you hang up or press **PHONE/FLASH** (to receive a call waiting call), the telephone automatically returns to dial pulse (rotary) service.

### Channel selection

---

During a call, if you hear clicks and pops, or if the speech sometimes fades, press **CHAN/REMOVE** on the handset to scan for a clearer radio channel between cordless handset and base.

## Call transfer for EL42208/EL42258



### Call transfer

---

During a conversation, you can transfer the call to the other cordless handset.

1. Press **MENU/SEL/TRANSFER** to transfer the external call to the other cordless handset. Your cordless handset will display **CALL TRANSFERED**. The other handset will begin ringing and **TRANSFERED CALL** will be displayed on the screen.
2. To answer the call, press **PHONE/FLASH**.



#### NOTES:

1. Before the transferred call is answered, the person at the originating handset can press **PHONE/FLASH** to cancel the transfer and resume the external call.
2. If the transferred call is not answered within 30 seconds, the originating handset will start ringing and show **TRANSFERED CALL**. If **PHONE/FLASH** is not pressed within another 30 seconds, the external call will end automatically.
3. If the destination cordless handset cannot be found, the cordless handset that originated the transfer will generate an error tone and continue the external call automatically.
4. This telephone does not have an intercom function. People using the cordless handsets cannot talk to each other.

## Call transfer for EL42308



### Call transfer

---

During a conversation, you can transfer the call to another cordless handset.

1. Press **MENU/SEL/TRANSFER** to transfer the external call to another cordless handset. The handset will display **CALL TRANSFERED**. All other handsets will begin ringing and **TRANSFERED CALL** will be displayed on the screen.
2. To answer the call, press **PHONE/FLASH**.



#### NOTES:

1. Before the transferred call is answered, the person at the originating handset can press **PHONE/FLASH** to cancel the transfer and resume the external call.
2. If the transferred call is not answered within 30 seconds, the originating handset will start ringing and show **TRANSFERED CALL**. If **PHONE/FLASH** is not pressed within another 30 seconds, the external call will end automatically.
3. If the destination cordless handset cannot be found, the cordless handset that originated the transfer will generate an error tone and continue the external call automatically.
4. This telephone does not have an intercom function. People using the cordless handsets cannot talk to each other.

## Call transfer for EL42408



### Call transfer

---

During a conversation, you can transfer the call to another cordless handset.

1. Press **MENU/SEL/TRANSFER** to transfer the external call to another cordless handset. The handset will display **CALL TRANSFERED**. All other handsets will begin ringing and **TRANSFERED CALL** will be displayed on the screen.
2. To answer the call, press **PHONE/FLASH**.



#### NOTES:

1. Before the transferred call is answered, the person at the originating handset can press **PHONE/FLASH** to cancel the transfer and resume the external call.
2. If the transferred call is not answered within 30 seconds, the originating handset will start ringing and show **TRANSFERED CALL**. If **PHONE/FLASH** is not pressed within another 30 seconds, the external call will end automatically.
3. If the destination cordless handset cannot be found, the cordless handset that originated the transfer will generate an error tone and continue the external call automatically.
4. This telephone does not have an intercom function. People using the cordless handsets cannot talk to each other.



## Directory

### Memory capacity

---

The handset directory can store up to 30 entries (including nine speed dial entries). Each entry can contain a number up to 24 digits, and a name up to 14 characters. A convenient search feature can help you find and dial numbers quickly (page 25).



**NOTE:** Each cordless handset has its own directory. Making changes to the directory of one handset will not affect the directories of the other handset(s).



### Timeouts & error messages

---

If you pause for too long while creating an entry, the telephone will time out and you will have to begin again.

If all memory locations are in use, the screen will display **MEMORY FULL**. You will not be able to store a new number until an existing one is deleted.



**NOTE:** The speed dial feature occupies up to nine of the thirty memory locations in the directory. For example, if there are only five speed dial entries, then up to 25 entries can be stored in the directory. If there are already 30 entries in the directory, no new directory and speed dial entries can be stored in memory until some of the existing ones are deleted.

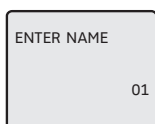
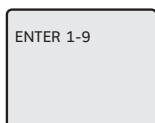
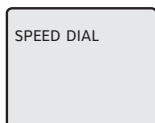

## Speed dial

You can enter nine speed dial numbers of up to 30 digits. Each number is stored in a speed dial location (1-9).

The nine speed dial numbers on the handset will be automatically added to the handset directory.

You can also make existing directory entries into speed dial entries (page 26).

### Enter a speed dial number

---

1. Press **MENU/SEL**.
2. Press **▼CID** or **DIR ▲** until the screen displays **SPEED DIAL**.
3. Press **MENU/SEL**.
4. Press a dial pad key (1-9) to select a speed dial location.
5. Enter a name up to 14 characters (page 23), then press **MENU/SEL**.
6. Enter a telephone number up to 24 digits (page 24), then press **MENU/SEL**.
7. Choose distinctive ringing (**N** or **Y**) by pressing **▼CID** or **DIR ▲**. If you choose yes (and if you have caller ID service), a different ringing style will alert you when this person calls.
8. Press **MENU/SEL** to store the number. You'll hear a confirmation tone.

### Call a speed dial number

---

To use speed dialing, press and hold a dial pad key (1-9) to display the number and name stored in that speed dial location, then press **☎PHONE/FLASH** to dial.

### Edit or delete a speed dial number

---

Press and hold a dial pad button (1-9) to display the entry you want. Press **MENU/SEL**, then press **▼CID** or **DIR ▲** until the option you want is displayed (page 26).



**NOTE:** You can convert any directory entry into a speed dial entry (page 26).

## New directory entries



**NOTE:** If all memory locations are in use, an error tone will sound when you attempt to enter a number. This means the memory is full, and you will not be able to store a new number until you delete an existing one.

DIRECTORY

ENTER NAME

PAT JOHNSON\_

### Create & store a directory entry

1. Press **MENU/SEL** in the idle mode to enter the handset main menu.
2. Press **MENU/SEL** again to enter the **DIRECTORY** menu.
3. Enter the name when prompted.
  - Use the dial pad to enter a name (up to 14 characters). See the chart below.
    - Press **DIR ▲** to move the cursor to the right. Press **▼CID** to move the cursor to the left.
    - Press **▼CID** or **DIR ▲** to move to the character you want to erase, then press **CHAN/REMOVE**.
4. When finished entering the name, press **MENU/SEL**.

Dial Key	Characters by number of key presses					
	1	2	3	4	5	6
1	1					
2	A	B	C	2		
3	D	E	F	3		
4	G	H	I	4		
5	J	K	L	5		
6	M	N	O	6		
7	P	Q	R	S	7	
8	T	U	V	8		
9	W	X	Y	Z	9	
0	0					
*	*					
#	&	'	,	-	.	#

## New directory entries

5. Enter the telephone number when prompted.

- Use the dial pad to enter up to 24 digits.
  - Press **DIR ▲** to move the cursor to the right. Press **▼CID** to move the cursor to the left.
  - Press **DIR ▲** or **▼CID** to move to the digit you want to delete, then press **CHAN/REMOVE** to erase the digit.
  - Press **REDIAL/PAUSE** to enter a four-second dialing pause. A **P** will be inserted.

**-OR-**

- Copy the last redial number by pressing **REDIAL/PAUSE**. Press **MENU/SELECT** to copy the number.

6. When finished entering the telephone number, press **MENU/SEL**.

7. Select desired ring pattern.

- Press **▼CID** or **DIR ▲** to select **Y** (if you want to assign a distinctive ring tone) or **N** (for a normal ring pattern). If you choose yes (and if you have caller ID service), a different ringing style will alert you when this person calls.

8. Press **MENU/SEL** to choose the desired option and store this entry in the directory.

ENTER NUMBER

PAT JOHNSON  
5556789\_

DISTINCT RING? N  
5556789



**NOTE:** A **D** appears in the display of each entry that has been assigned a distinctive ring.

## Directory search

### Review directory entries

---

1. Press **DIR ▲** in idle mode. **DIRECTORY EMPTY** will be displayed if there are no directory entries in that handset.
2. Press **▼CID** or **DIR ▲** to browse through the directory.
3. Press **OFF/CLEAR** to exit the directory.

DIRECTORY

ADAM  
5551234

BETH  
5554321



#### NOTES:

1. When reviewing directory entries, all entries (including those in the directory and in the speed dial) are displayed in alphabetical order. The entries in the speed dial are identified by its speed dial number (01-09) in the lower right corner of the screen (page 22).
2. A **D** appears in the display of each entry that has been assigned a distinctive ring (page 24).

### Search by name

---

To shorten your search, press **DIR ▲** then use the telephone dial pad keys to enter the first letter of a name, then press **DIR ▲** to scroll forward until you find the desired name.

If you have more than one name entry that begins with the same letter, it is necessary to scroll through all the names beginning with that letter before seeing names that begin with the next letter.

Press dial pad keys once for the first letter, twice for the second, three times for the third.

For example, if you have name entries **JENNIFER**, **KEVIN** and **LINDA** in your directory, pressing the dial pad key **5** (JKL) once will show **JENNIFER**, twice **KEVIN**, three times **LINDA**.

JOHN  
5550123



**NOTE:** When searching alphabetically and you press a dial pad button, if there are no entries beginning with the letters on that button, the handset will show **NO DATA**.

## Change or dial entries

When any entry is displayed, press **MENU/SEL** to see options. Press **▼CID** or **DIR ▲** to highlight the option you want (blinking text), then press **MENU/SEL** again to select it.

### Edit an entry

---



When **EDIT** is blinking, press **MENU/SEL**. You can change the name and number (or distinctive ring setting on the cordless handset) by following the steps described on pages 23-24.

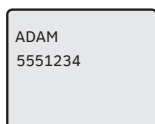

### Delete an entry

---

Press **▼CID** or **DIR ▲** until **DEL** is blinking, then press **MENU/SEL** to display a confirmation screen of **ERASE NO YES**.

You can press **▼CID** or **DIR ▲** to alternate between **NO** or **YES** to determine:

- When **YES** is blinking, press **MENU/SEL** to delete the entry.
- When **NO** is blinking, press **MENU/SEL** to cancel the procedure.

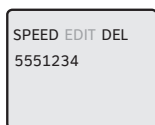

**NOTE:** Each cordless handset has its own directory. Making changes to the directory of one handset will not affect the directories of the other handset(s).

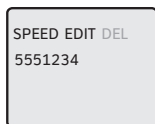

### Change a directory entry into a speed dial entry

---

Press **▼CID** or **DIR ▲** until **SPEED** is blinking, press **MENU/SEL**, then press a memory location (1-9) to transfer this entry to your speed dial directory.



**NOTE:** If you use a memory location that is already assigned to a different entry in the directory the original entry will remain in the directory, but will no longer be a speed dial number.

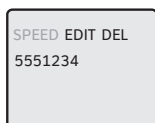

### To dial a directory entry (display dial)

---

When any directory entry is displayed, press **☎PHONE/FLASH** to dial the displayed number.

## Caller ID history

### About caller ID with call waiting

---

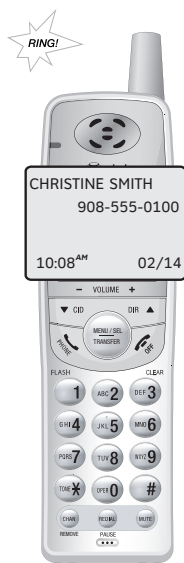

This product has a caller ID function with call waiting feature which works with service from your local telephone company.

Caller ID with call waiting lets you see the name and telephone number of the caller before answering the telephone, even while on another call.

It may be necessary to change your telephone service to use this feature. Contact your telephone company if:

- You have both caller ID and call waiting, but as separate services (you may need combined service).
- You have only caller ID service, or only call waiting service.
- You do not have any caller ID or call waiting services.

This product can be used with regular caller ID service, or this product's other features can be used without subscribing to either caller ID or combined caller ID with call waiting service.

There are fees for caller ID services. In addition, services may not be available in all areas.

Depending on your service, you may see the caller's number or the caller's name and number. This product can provide information only if both you and the caller are in areas offering caller ID service and if both telephone companies use compatible equipment. The time and date are sent by the telephone company along with the call information.

## Caller ID history

### How caller ID works

If you subscribe to caller ID service provided by your local telephone company, information about each caller will be displayed between the first and second ring.

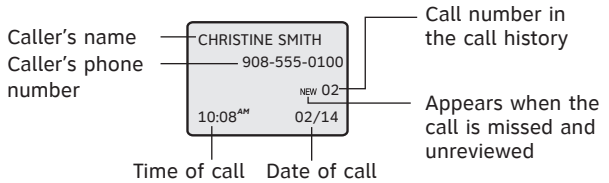

Information about the last 30 incoming calls is stored in the call history. You can review the call history to find out who has called, return the call, or copy the caller's name and number into directory.

When the call history is full, the oldest entry is deleted to make room for new incoming call information.

If you answer a call before the information appears on the screen, it will not be saved in the call history.

### About names

Names of callers will be displayed only if the information is provided by your local telephone company.

If the incoming telephone number exactly matches a telephone number in your directory, the name that appears on the screen will match the corresponding name in your directory.

For example: If Christine Smith calls, her name will appear as **CHRIS** if this is how you entered it into your directory.



#### NOTES:

1. Caller ID features will work only if both you and the caller are in areas offering caller ID service, and if both telephone companies use compatible equipment.
2. The number shown by your caller ID will be in the format sent by the telephone company. The telephone company usually delivers 10-digit telephone numbers (area code plus telephone number). If the telephone number of the person calling does not exactly match a number in your directory, the name will appear as delivered by the telephone company. For example if the telephone company includes the area code and the directory number does not, the name will appear as delivered by the telephone company.



## Caller ID history

There are also occasions when other information or no information is displayed for various reasons:



On-screen message	Reason
PRIVATE NAME	Caller prefers to remain anonymous.
PRIVATE CALLER	Caller name and telephone number not revealed at caller's request.
UNKNOWN NAME	Your local telephone company is unable to determine the caller's name.
UNKNOWN CALLER	Your local telephone company is unable to determine the caller's name and telephone number. Calls from other countries may also generate this message.

02 MISSED CALLS

10:08 AM 02/14

Pat Williams

555-1234

10:08 AM NEW 01  
02/14

### Missed (new) call indicator

When a handset is not in use and has calls that have not been reviewed, its screen will show **XX MISSED CALLS**.

Any entries which have not been reviewed will be counted as **MISSED CALLS** when the telephone is idle. Each time a call history entry marked **NEW** is reviewed, the number of missed calls decreases by one.

If there are too many missed calls and you don't want to review them one by one, but still want to keep them in the call history, press and hold **OFF/CLEAR** for two seconds when the handset is idle. All the entries in the caller ID history will be considered old (have been reviewed), and the missed calls counter is reset to 0.

## Review the call history

PAT JOHNSON	908-555-0100
	NEW 03
10:08 <sup>AM</sup>	02/14

CHRIS WILLIAMS	908-555-1234
	NEW 02
10:08 <sup>AM</sup>	02/14

PHONE	0:00:10
9085551234	

PAT JOHNSON	908-555-0100
	NEW 03
10:08 <sup>AM</sup>	02/14

**-OR-**

PAT JOHNSON	908-555-0100
	NEW 03
10:08 <sup>AM</sup>	02/14

PAT JOHNSON	1-908-555-0100
	NEW 03
10:08 <sup>AM</sup>	02/14

PAT JOHNSON	555-0100
	NEW 03
10:08 <sup>AM</sup>	02/14

PAT JOHNSON	1-555-0100
	NEW 03
10:08 <sup>AM</sup>	02/14

The call history displays the caller ID in reverse chronological order, with the latest one (the one with the highest number) first.

When the telephone is not in use, press **▼CID** to display information about the most recent caller.

### Review your call history

---

Press **▼CID** to scroll backward (display older calls) or **DIR ▲** to scroll forward (display newer calls). The highest call number is the most recent call received.

Each unreviewed caller ID entry in the call history will be designated **NEW** until you have reviewed it. After all calls have been reviewed, **NEW** will disappear from the screen.

### Return a call (display dial)

---

Press **\PHONE/FLASH** to call the number currently displayed.



**NOTE:** If the number displayed is not in the correct format, see **Dialing options** for detail.

### Dialing options

---

Caller ID numbers may appear with an area code that may not be required for local calls.

If the number displayed is not in the correct format, you can change how it is dialed. Press **#** repeatedly to see dialing options. With each button press, a new option will be displayed. Press **\PHONE/FLASH** to dial when the number appears in the proper format for your area.

The various dialing options are:

908-555-0100

1-908-555-0100

555-0100

1-555-0100

## Delete call history entries

### Delete a single call history entry

Press **▼CID** to display the latest caller ID listing. Use the **▼CID** or **DIR ▲** keys to find the entry you want to delete, then press **CHAN/REMOVE**. When the entry is deleted, the next oldest record is displayed.

PAT JOHNSON  
908-555-0100  
NEW 03  
10:08<sup>AM</sup> 02/14

CHRIS WILLIAMS  
908-555-1234  
NEW 02  
10:08<sup>AM</sup> 02/14

MARK CLAYTON  
908-555-5678  
NEW 01  
10:08<sup>AM</sup> 02/14

**-OR-**

27 MISSED CALLS  
10:08<sup>AM</sup> 02/14

ERASE ALL? N Y

ERASE ALL? N Y

10:08<sup>AM</sup> 02/14

### Delete all call history entries

To clear your call history completely, press and hold **CHAN/REMOVE** while the telephone is idle (not in use). This will display a confirmation screen asking if you want to erase all entries in the caller ID history. If you select yes, the call history will be cleared and the screen will return to normal standby display, and the missed calls counter is reset to 0.



#### NOTES:

1. Each cordless handset has its own call history. When you delete one or all call history entries from one cordless handset, the information on all other cordless handsets will not be affected.
2. When there are already 30 entries in the caller ID memory, the next incoming call will automatically cause the oldest entry to be deleted from the caller ID memory of the handset.

## Add entries to the directory

### Add entries to the directory

---

While you have a caller ID entry displayed, follow the steps below to enter it into your telephone directory.

1. Press **▼CID** in idle mode. **CID EMPTY** will be displayed if there are no call history entries in that handset.
2. Press **MENU/SEL**, then press **▼CID** or **DIR ▲** until **PROGRAM** is flashing.
3. Press **MENU/SEL** and edit the name and number as desired.
4. Press **MENU/SEL**, then press **▼CID** or **DIR ▲** to alternate between **Y** and **N**. If you choose **Y** (and if you have caller ID service), a distinct ring tone will alert you when this person calls.
5. Press **MENU/SEL** to confirm, the entry is added to the phone directory.



**NOTE:** The entry copied to your telephone directory remains in the call history until deleted.

PAT JOHNSON  
908-555-0100  
NEW 03  
10:08<sup>AM</sup> 02/14

DIAL PROGRAM  
908-555-0100  
NEW 03  
10:08<sup>AM</sup> 02/14

PAT JOHNSON  
9085550100

PAT JOHNSON  
9085550100\_

DISTINCT RING? N  
9085550100

PAT JOHNSON  
908-555-0100  
NEW 03  
10:08<sup>AM</sup> 02/14

## Answering system

### Message capacity

The answering system can record up to 95 messages depending on the length of each message. Individual messages can be up to four minutes. The maximum record time can be more than 11 minutes. The actual recording time depends on individual message characteristics. Messages will remain available for replay until you delete them.

### Voice prompts

Each time you press any answering system key, the answering system uses voice prompts to guide you.



#### Message counter

Number of messages (or during playback, message number currently playing).

Press to repeat message; press **twice** to play previous message (page 37).

Press to turn answering system on or off (page 40).

Press to review time and day or set clock (page 34).

Press repeatedly to hear setup options (page 36).

Press to review or record announcement; press again to quit (page 35).

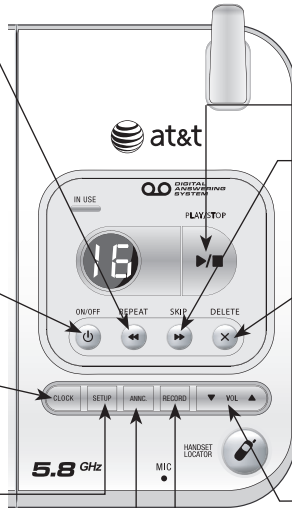

Press to start or stop message playback (page 37).

Press to skip a message (page 37).

Press to delete message currently playing; press twice to delete all old messages while the phone is not in use (page 37).

Press to adjust playback volume (page 37).

Press to record a memo (page 38) or after pressing **ANNC.** to record an outgoing announcement (page 35).

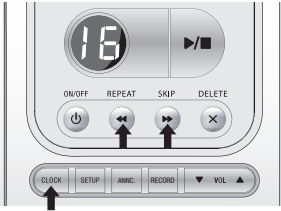

## Day & time announcements

### Check day & time

---

You can press **CLOCK** at any time to hear the current day and time without changing it.

### Set day & time

---

Before playing each message, the answering system announces the date and time when the message was received.

Follow the steps below to set the day, time and year, so that messages are dated correctly. Each time you press **▶SKIP** or **◀REPEAT**, the day, hour, minute or year increases or decreases by one. Press and hold **▶SKIP** or **◀REPEAT** to increase or decrease the minutes or year by increments of 10. When you hear the correct setting, press **CLOCK** to move to the next setting.



#### NOTES:

1. If the clock was not set when the message was recorded, the system will announce "Time and day not set."
2. Caller ID provides the time and date. Set the year so that the day of the week can be calculated from the caller ID information. After you set the time once, it will thereafter be set automatically with incoming caller ID information. The time will be set automatically only if you subscribe to caller ID service provided by your local telephone company (page 27).

1. Press **CLOCK**, The system will announce the current clock setting, then announces "To set the clock, press **CLOCK**."
2. Press **CLOCK**, The system will announce the current day setting, then announces "To change the day, press **▶SKIP** or **◀REPEAT**, to change the hour, press **CLOCK**."
3. Press **CLOCK**, The system will announce the current hour setting, and then announce "To change the hour, press **SKIP** or **REPEAT**, to change the minute, press **CLOCK**."
4. Press **CLOCK**, The system will announce the current minute setting, and then announce "To change the minute, press **SKIP** or **REPEAT**, to change the year, press **CLOCK**."
5. Press **CLOCK**, The system will announce the current year setting, and then announce "To change the year, press **SKIP** or **REPEAT**, press **CLOCK** when you are done."
6. Press **CLOCK**. The system announces the current clock setting.

## Outgoing announcements

The outgoing announcement is the message callers hear when calls are answered by the answering system.

The telephone is factory set with an announcement. If the telephone is set up to record messages, it answers calls with *"Hello. Please leave a message after the tone."* You can use this announcement, or replace it with a recording of your own voice.

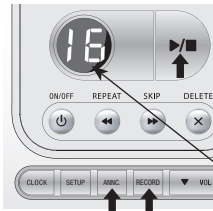

Elapsed recording time (in seconds).



**NOTE:** While recording, the elapsed time (in seconds) will be shown in the message window. You can record an announcement up to 90 seconds long. Announcements shorter than two seconds long will not be recorded.

### Play your outgoing announcement

1. Press **ANNC.**, you will hear *"Announcement. Press **PLAY** or press **RECORD.**"*
2. Press **▶/■ PLAY/STOP**. You will hear the outgoing announcement.
3. Press **ANNC.** to exit the announcement menu.

### Record your outgoing announcement

1. Press **ANNC.**, you will hear *"Announcement. Press **PLAY** or press **RECORD.**"*
2. Press **RECORD** and begin speaking after hearing *"Record after the tone. Press **STOP** when you are done."* Speak facing the telephone base from about nine inches away.
3. Press **▶/■ PLAY/STOP** when you are done. Your recorded announcement will be played back.
4. Press **ANNC.** to exit the announcement menu.

### Delete your outgoing announcement

1. Press **ANNC.**, you will hear *"Announcement. Press **PLAY** or press **RECORD.**"*
2. Press **▶/■ PLAY/STOP** to begin playback.
3. Press **XDELETE** during playback to delete your announcement.
4. Press **ANNC.** to exit the announcement menu.

When your announcement is deleted, calls will be answered with the factory set announcement.

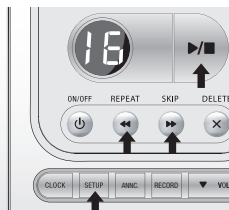

## Changing feature options

You can set and change the answering system features described below:

1. Press **SETUP** repeatedly until you hear the feature you want to modify.
2. Press **▶SKIP** or **◀REPEAT** to change the setting.
3. Press **SETUP** to set your selection and move to the next menu option.
4. Press **▶■PLAY/STOP** to confirm the setting and exit the menu.

### Feature options (Default settings underlined)



#### NOTES:

1. The message alert tone will beep only if all the conditions below are met:
  - Answering system is on;
  - Message alert tone setting is on;
  - There are new messages.
2. Press any base key to temporarily silence the message alert tone. If you press **X DELETE** twice while the phone is not in use, you will delete all old messages and the message alert tone will be temporarily silenced. The message alert tone will be re-activated with the next incoming message.

System announces:	Feature description:
<p>"Number of rings," current setting, then "To change the setting press <b>SKIP</b> or <b>REPEAT</b>; to continue setup, press <b>SETUP</b>." Options: 2/<u>4</u>/6/toll saver</p>	<p>Choose number of rings before the system answers a call. When toll saver is active, the system answers after two rings if you have new messages, and after four rings if you have no new messages. If you are making a long distance call to retrieve messages, you may disconnect your call after three rings so that there will be no long distance charge incurred.</p>
<p>"Base ringer," current setting, then "To change the setting, press <b>SKIP</b> or <b>REPEAT</b>; to continue setup, press <b>SETUP</b>." Options: high/<u>low</u>/off</p>	<p>Choose the base ringer volume between high and low level, or turn the base ringer off.</p>
<p>"Remote access code," current setting, then "To change the setting press <b>SKIP</b> or <b>REPEAT</b>; to continue setup, press <b>SETUP</b>." Options: (select a two-digit code) <u>19</u></p>	<p>Select a two-digit number (10-99) for remote access from another telephone (page 41).</p> <p> <b>NOTE:</b> Press and hold <b>▶SKIP</b> or <b>◀REPEAT</b> to increase or decrease the remote access code number by 10.</p>
<p>"Message alert tone," current setting, then "To change the setting, press <b>SKIP</b> or <b>REPEAT</b>; to continue setup, press <b>SETUP</b>." Options: on/<u>off</u></p>	<p>When on, the telephone beeps every 10 seconds when there are new messages.</p>



Number of messages (or during playback, message number currently playing).

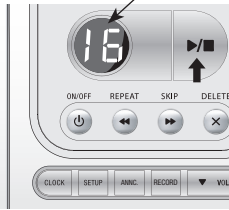

Press **▶/■ PLAY/STOP** to begin or end message playback.

**1.** Press **▶/■ PLAY/STOP**

 *"You have [XX] new messages and [XX] old messages"*

Message playback begins. See options at right.

**2.** Press **▶/■ PLAY/STOP** to end message playback.



**NOTES:**

1. If **F** and the total message number is flashing in the message window, memory is full. You will have to delete some messages before new ones can be received.
2. The maximum record time can be more than 11 minutes.
3. If you receive calls when the memory is full, the telephone will ring 10 times, then answer and announce *"Memory is full, enter the remote access code."*
4. New (unheard) messages cannot be deleted.

## Message playback

Press **▶/■ PLAY/STOP** to listen to messages. The system announces the number of messages, then begins playback.

If you have new messages, you will hear only the new messages (oldest first). If there are no new messages, the system will playback all messages (oldest first).

## Announcements

---

- When playback begins, you will hear the total number of messages.
- Before each message, you will hear the day and time it was received.
- After playing all new messages, you will hear *"End of new messages."* You will hear "End of messages" after the answering system has finished the playback of all messages. If the system has less than five minutes of recording time left, you will hear the estimated time remaining.

## Options during playback

---

- Press **▲VOL** button to adjust the speaker volume.
- Press **▶▶SKIP** to skip to next message.
- Press **◀◀REPEAT** to repeat the message currently playing. Press twice to hear previous message.
- Press **✕DELETE** to delete the message being playback.
- Press **▶/■ PLAY/STOP** to stop playback.

## Delete all messages

---

To delete all old messages, press **✕DELETE** twice while the telephone is not in use.

## Record & play memos

Memos are messages you record yourself. They are saved, played back and deleted exactly like incoming messages. You can record a memo as a reminder to yourself, or leave a message for someone else if other members of your household are using the answering system.

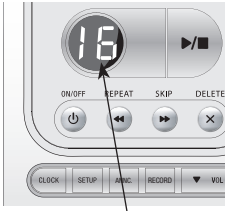

Elapsed recording time (seconds).

1. Press **RECORD**  
 "Record after the tone. Press **STOP** when you are done."

2. Speak into microphone.

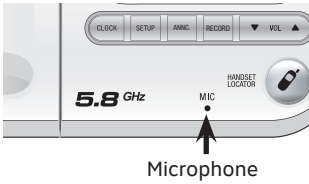

Microphone

3. Press **PLAY/STOP**  
 "Recorded, beep."

### Record a memo

---

1. Press **RECORD**. Elapsed time (in seconds) is shown in the message window as you record.
2. Press **PLAY/STOP** to stop recording.

 **NOTE:** You can record a memo up to four minutes. Memos less than one second will not be saved.

### Play back a memo

---

Press **PLAY/STOP** to hear messages and memos (see page 37 for other options).

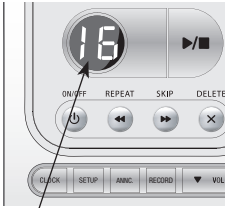

Message counter.

## Message counter displays

When the answering system is idle, the message counter displays the total number of answering system messages. See the list below for explanations of other displays in this counter.

### Message counter displays

0	No messages.
0 ( <i>flashing</i> )	The clock needs to be set (page 34).
1-95	Total number of messages and memos, or message number currently playing.
1-95 ( <i>flashing</i> )	Total number of messages and memos. The number flashes when there are new (unreviewed) messages.  If the telephone loses power, after power is restored, the number in the message counter will flash (even if you have only old messages) to indicate the clock needs to be set.
10-99	Current remote access code while setting (page 36).
1-99 ( <i>counting</i> )	Elapsed time while recording a memo (page 38) or announcement up to 90 seconds (page 35).
99 ( <i>flashing</i> )	Memo recording time has exceeded the maximum counter capacity of 99 seconds.
F ( <i>flashing</i> )	Memory is full. Messages must be deleted before new messages can be received.
--	System is answering a call, being accessed remotely, or the clock is being set, or a handset is on a call.
-- ( <i>flashing</i> )	System is being setup or initialized.
2, 4, 6, tS	Current number of rings-to-answer while setting this feature (page 36).
1-8	Displayed for two seconds while telephone base speaker volume is being adjusted.
HI, LO, OF	Displayed for two seconds while telephone base ringer volume is being adjusted.

## Answering system mode

The answering system's default factory setting is **ON** in order to answer and record messages. You can turn the answering system off, but if you do so, the answering system will not answer calls or record incoming messages.



1. Press **ON/OFF** until the system announces "Calls will not be answered."

2.  "Beep."  
The system has been turned off.

**-OR-**

1. Press **ON/OFF** until the system announces "Calls will be answered."

2.  "Beep."  
The system has been turned on.

### Turn the answering system off

---

Press **ON/OFF** until you hear "Calls will not be answered" and a confirmation beep. The **ON/OFF** will be turned off.



**NOTE:** If the answering system is off and someone calls, the telephone will ring 10 times then answer and announce "Please enter your remote access code." Enter your remote access code to enter remote access mode (page 41). If you do not enter the correct remote access code, the call will be ended automatically.

### Turn the answering system on

---

Press **ON/OFF** until you hear "Calls will be answered" then a beep to confirm the **ON** setting. The **ON/OFF** light will be turned on.

### Call screening

---

If the answering system is on and the base volume is not set to off (volume level 1), you will hear the announcement and the incoming message when a call comes in.

### Call intercept

---

While you are call screening, you can intercept the call by pressing **PHONE/FLASH** on the handset.

## Remote access

A two digit security code is required to access your answering system from any touch-tone telephone. This code is **19** by default, see **Changing feature options** (page 36) to change it.

1. Dial your telephone number from any touch-tone telephone.
2. When the system answers, enter two digit remote access code (**19** unless you have changed it).
3. Enter remote commands (see list at right).
4. Hang up to end the call and save all undeleted messages.

<b>Play all messages</b> <b>1</b>	Press to hear all messages.
<b>Play new messages</b> <b>2</b>	Press to hear new messages.
<b>Delete the message</b> <b>3</b> <b>33</b>	Press once during playback to delete current message. Press twice to delete all old messages.
<b>Repeat or go back</b> <b>4</b>	Press during the caller's message to repeat the message. Press during the beginning of the day and time announcement to go back to the previous message.
<b>Stop</b> <b>5</b>	Press to stop any operation (stop playback, stop recording).
<b>Skip to next message</b> <b>6</b>	Press to skip the current message and advance to next message.
<b>Record announcement</b> <b>*7</b> to begin recording <b>5</b> to stop recording	Press <b>*7</b> , wait for the beep, then begin speaking. Press <b>5</b> to stop recording and hear the playback of new announcement.
<b>Help menu</b> <b>*5</b>	Press to hear list of features & commands.
<b>Turn system off</b> <b>0</b>	Press to turn off answering system. Incoming calls will no longer be answered.
<b>Turn system on</b> <b>0</b>	If off, system will answer after 10 rings. Enter your access code, then press <b>0</b> to turn the answering system on.
<b>Exit</b> <b>8</b>	Press <b>8</b> or hang up to end the remote access call.



**NOTE:** If you pause for more than four seconds during remote access, you will hear a help menu listing all features and commands. If there is no command entered for another 15 seconds, the call will end automatically.



# Screen icons, indicator lights & tones

## Screen icons & alert tones

---



### Screen icons

- MUTE** Microphone is muted.
-  Ringer off.
-  Low battery (flashing); place handset in telephone base or charger to recharge.
- NEW** Missed and unreviewed calls.

## Handset alert tones

- Two short beeps** The volume level is at the maximum or minimum setting.
- Double beep every minute when on a call** Low battery warning.
- Four beeps** Out of range when on the line.
- Five beeps** Error tone.
- Confirmation tone** Command completed successfully.

## Telephone base tones

- One beep every 10 seconds** Message alert.
- A series of beeps** Press **⬆VOL** keys while the volume level is already at the maximum or minimum setting.

## Indicator lights

---

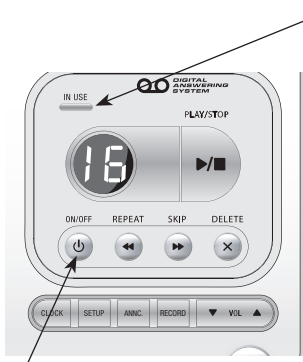

- IN USE**
  - On steady when the handset is in use.
  - Flashes quickly while an incoming call is ringing.

**ON/OFF**  
The light is on when the answering system is on and ready to receive messages.

### CHARGE

The light is on when the cordless handset is properly positioned to charge in the telephone base.

Large lighted display

Lighted dial pad



# Handset display screen messages



## Screen display messages

CONNECTING...	The cordless handset is waiting for a dial tone.
** RINGING **	There is an incoming call.
** PAGING **	The cordless handset locator has been activated (all cordless handsets beep to help you locate them).
LOW BATTERY	Cordless handset battery is low. Place the cordless handset in the base or charger to charge the battery.
SCANNING...	Cordless handset is scanning for a clear channel to improve sound quality.
XX MISSED CALLS	There are missed and unreviewed calls in your call history.
RINGER OFF	The cordless handset ringer is turned off.
MEMORY FULL	The handset directory is full.
MIC MUTED	The handset microphone is temporarily muted.
MIC ON	The handset microphone is no longer muted.
SYSTEM HS BUSY	Another cordless handset is on a call.
CALL TRANSFERED	You are transferring an external call on your cordless handset to another system (destination) handset.
TRANSFERED CALL	The destination system handset is receiving a transferred call. Or, when the transferred call is not answered within 30 seconds on the destination handset, the originating handset displays this message and starts ringing.

# Handset display screen messages

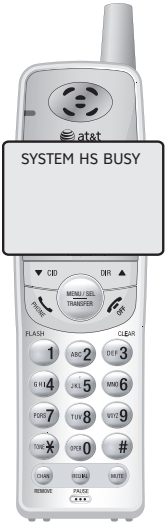

## Screen display messages

---

PARALLEL SET ON	Another telephone on the same line is in use.
POWER FAILURE followed by OR OUT OF RANGE	Cordless handsets cannot communicate with the base. Check base power, or move closer.

---



## Troubleshooting

If you have difficulty with your telephone, please try the suggestions below. For Customer Service, visit our website at [www.telephones.att.com](http://www.telephones.att.com) or call **1 (800) 222-3111**. In Canada, dial **1 (866) 288-4268**.

My telephone does not work at all.

- Make sure the battery is installed and charged correctly (page 9). For optimum daily performance, return the cordless handset to the telephone base after use.
- Make sure the power adapter is securely plugged into an outlet not connected to a wall switch.
- Make sure the telephone line cord is plugged firmly into the telephone base and the modular wall jack.
- Unplug the telephone's electrical power. Wait for approximately 15 seconds, then plug it back in. Allow up to one minute for the cordless handset and base to synchronize.
- Charge the battery in the cordless handset for at least 16 hours.
- Remove and re-insert the battery. If that still does not work, it may be necessary to purchase a new battery.
- Disconnect the telephone base from the modular jack and plug in a working telephone. If this telephone does not work, the problem is probably in the wiring or the local service. Call the local telephone company.

---

**LOW BATTERY** is displayed on screen.

- Place the handset in the telephone base for recharging. The **CHARGE** light on the handset should be on as soon as the handset is properly placed on the telephone base. If the handset has not been used for a long time or if the battery inside is completely depleted. Depending on the strength of the battery in the handset, it may take up to 10 minutes before the handset screen shows **NEEDS CHARGING**.
- Remove and re-install the battery and use it normally until fully discharged, then recharge the handset on the telephone base for 16 hours.
- If the above measures do not correct the problem, the battery may need to be replaced.

## Troubleshooting

The battery does not charge in the handset or the handset battery does not accept charge.

- Make sure the handset is placed in the telephone base correctly. The **CHARGE** light on the handset should be on.
  - If the cordless handset is in the telephone base, but the **CHARGE** light is not on, refer to **The CHARGE light is off** in this section.
  - It may be necessary to purchase a new battery. Please refer to the **Batteries** section of this user's manual.
  - The telephone might be malfunctioning. Please refer to the **Limited warranty** section of this user's manual for further instruction.
- 

The **CHARGE** light is off.

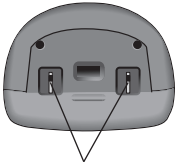

- Clean the metallic charging contacts on the cordless handset and telephone base each month using a pencil eraser or a dry non-abrasive fabric.
  - Make sure the power adapter and telephone line cords are plugged in correctly and securely.
  - Unplug the power adapter. Wait for 15 seconds before plugging it back in. Allow up to one minute for the cordless handset and telephone base to reset.
  - The telephone might be malfunctioning. Please refer to the **Limited warranty** section of this user's manual for further instruction.
- 

There is no dial tone.

- First, try all the suggestions in **My telephone does not work at all**, on the previous page.
- Move the cordless handset closer to the telephone base. It might be out of range.
- The telephone line cord might be malfunctioning. Try installing a new telephone line cord.
- Disconnect the telephone base from the telephone jack and connect a different telephone. If there is no dial tone on that telephone either, the problem is in your wiring or local service. Contact your local telephone company.

## Troubleshooting

The telephone does not ring when there is an incoming call.

- Make sure the ringer is on (page 12).
- Make sure the telephone line cord and power adapter are plugged in properly (page 6).
- The cordless handset may be too far from the telephone base. Move it closer to the telephone base.
- There may be too many extension telephones on the telephone line to allow all of them to ring simultaneously. Try unplugging some of them.
- If the other telephones in your home are having the same problem, the problem is in the wiring or local service. Contact the local telephone company (charges may apply).
- Other electronic products can cause interference to your cordless telephone. Try installing your telephone as far away as possible from the following electronic devices: wireless routers, radios, radio towers, pager towers, cellular telephones, digital telephones, intercoms, room monitors, televisions, VCRs, personal computers, kitchen appliances, and other cordless telephones.
- Test a working telephone at the same telephone jack. If another telephone has the same problem, the problem is in the telephone jack. Contact your local telephone company (charges may apply).
- The telephone line cord might be malfunctioning. Try installing a new telephone line cord.
- Re-install the battery and place the cordless handset in the telephone base.
- Wait for the cordless handset to synchronize with the telephone base. Allow up to one minute for this to take place.

---

My phone rings but when I try to answer the call the handset screen shows **CONNECTING...**

- The cordless handset may be too far from the telephone base. Move closer to the telephone base and try to answer the call.

## Troubleshooting

I cannot dial out.

- First, try all the suggestions in **The telephone does not ring when there is an incoming call**, on the previous page.
- Make sure there is a dial tone before dialing. It is normal if the cordless handset takes a second or two to synchronize with the telephone before producing a dial tone. Wait an extra second before dialing.
- Make sure the telephone is set to the correct dial mode (pulse dial or tone dial) for the service in your area. Refer to the **Dial mode** section of this user's manual (page 11) to set the dial mode.
- If the other telephones in your home are having the same problem, the problem is in the wiring or local service. Contact your local telephone company (charges may apply).
- Eliminate any background noise. Noise from a television, radio, or other appliances may cause the telephone to not dial out properly. If you cannot eliminate the background noise, first try muting the cordless handset before dialing, or dialing from another room in your home with less background noise.

---

There is noise or interference during a telephone conversation.

- The handset may be out of range. Move it closer to the telephone base.

---

My calls fade out or cut in and out when I am using the cordless handset.

- Appliances or other cordless telephones plugged into the same circuit as the telephone base can cause interference. Try moving the appliance or telephone base to another outlet.
- Other electronic products can cause interference to your cordless telephone. Try installing your telephone as far away as possible from the following electronic devices: wireless routers, radios, radio towers, pager towers, cellular telephones, digital telephones, intercoms, room monitors, televisions, VCRs, personal computers, kitchen appliances, and other cordless telephones.
- Microwave ovens operate on the same frequency as your telephone. It is normal to experience static on your telephone while the microwave oven is operating. Do not install this telephone in the same outlet or near a microwave oven.

## Troubleshooting

- If your telephone is plugged in with a modem or a surge protector, plug the telephone (or modem/surge protector) into a different location. If this doesn't solve the problem, re-locate your telephone or modem farther apart from each other, or use a different surge protector.
- The layout of your home or office might be limiting the operating range. Try moving the telephone base to another location, preferably a higher location for better reception.
- Disconnect the telephone base from the modular jack and plug in a corded telephone. If calls are still not clear, the problem is probably in the wiring or local service. Contact your local service company (charges may apply).
- Select channels four through 10 for your router (refer to the user's manual of your router for more information).
- If the other telephones in your home are having the same problem, the problem is in the wiring or local service. Contact the local telephone company (charges may apply).
- If you subscribe to high-speed Internet service (Digital Subscriber Line - DSL) through your telephone line, you must install a DSL filter between the telephone base and the telephone wall jack (see page 6). The filter will prevent noise and caller ID problems caused by DSL interference. Please contact your DSL service provider for more information about DSL filters.

---

I hear other calls when using the telephone.

- Disconnect the telephone base from the telephone jack. Plug in a different telephone. If you still hear other calls, the problem is probably in the wiring or local service. Call your local telephone company.

---

The announcement message is not clear.

- When recording the announcement, make sure you speak in a normal tone of voice about nine inches from the telephone base.
- Make sure there is no background noise (television, music, traffic, etc.) when recording.

## Troubleshooting

My caller ID features are not working properly.

- Caller ID is a subscription service. You must subscribe to this service from your local telephone company for this feature to work on your telephone.
- The caller may not be calling from an area that supports caller ID.
- Both you and the caller's telephone companies must use equipment compatible with caller ID service.
- If you subscribe to high-speed Internet service (Digital Subscriber Line - DSL) through your telephone line, you must install a DSL filter between the telephone base and the telephone wall jack (page 6). The filter will prevent noise and caller ID problems caused by DSL interference. Please contact your DSL service provider for more information about DSL filters

---

The system does not receive caller ID or the system does not display caller ID during call waiting.

- Make sure you subscribe to caller ID with call waiting features services provided by the local telephone company.
- The caller may not be calling from an area that supports caller ID.
- Both you and the caller's telephone companies must use equipment compatible with caller ID service.
- If you subscribe to high-speed Internet service (Digital Subscriber Line - DSL) through your telephone line, you must install a DSL filter between the telephone base and the telephone wall jack (page 6). The filter will prevent noise and caller ID problems caused by DSL interference. Please contact your DSL service provider for more information about DSL filters.

---

*"Time and day not set"* prompts.

- You need to set the answering system clock (page 34).

---

The answering system does not answer after the correct number of rings.

- Make sure the answering system is on. When the answering system is on, the red light on the **ON/OFF** key should be lit.
- If toll saver is activated, the number of rings changes to two when there are new messages waiting (page 36).
- If the memory is full or if the answering system is off, the system will answer after 10 rings. If the memory is full, you need to delete some old messages in order to make room for new messages.
- In some cases, the answering system may be affected by the ringing system used by the local telephone company.

## Troubleshooting

- 
- |  |  |
|--|--|
| The answering system does not record messages. | <ul style="list-style-type: none"><li>• Make sure the answering system is on.</li><li>• If the memory is full the system will answer after 10 rings and announce “<i>Memory is full. Enter the remote access code.</i>” You need to delete some old messages in order to make room for new messages.</li></ul> |
|--|--|
- 
- |  |   |
|--|---|
| The messages on the answering system are incomplete. | <ul style="list-style-type: none"><li>• If a caller reaches the maximum recording time of four minutes, for each message, the system will disconnect and part of the message may be lost.</li><li>• If the caller pauses for more than seven seconds, the system stops recording and disconnects the call.</li><li>• If the memory on the system becomes full during a message, the system stops recording and disconnects the call.</li><li>• If the caller’s voice is very soft, the system may stop recording and disconnect the call.</li></ul> |
|--|---|
- 
- |   |   |
|---|---|
| The messages on the system are difficult to hear. | <ul style="list-style-type: none"><li>• Press <b>▲VOL</b> on the telephone base to increase the speaker volume.</li></ul> |
|---|---|
- 
- |   |  |
|---|--|
| The answering system does not respond to remote commands. | <ul style="list-style-type: none"><li>• Make sure your remote access code is correct (page 41).</li><li>• Make sure you are calling from a touch-tone telephone. When dialing a number, you should hear tones. If you hear clicks, then it is not a touch-tone telephone and cannot activate the answering system.</li><li>• The answering system may not detect the remote access code when your announcement is playing. Wait until the announcement is over before entering the code.</li><li>• There may be interference on the telephone line you are using. Press the dial pad keys firmly when dialing.</li></ul> |
|---|--|
- 
- |                                       |  |
|---------------------------------------|--|
| Common cure for electronic equipment. | <ul style="list-style-type: none"><li>• If the telephone is not responding normally, try putting the cordless handset in the telephone base. If it does not seem to respond, try the following (in the order listed):<ol style="list-style-type: none"><li>1. Disconnect the power to the telephone base.</li><li>2. Disconnect the battery on the cordless handset.</li><li>3. Wait a few minutes before connecting power to the telephone base.</li><li>4. Re-install the battery and place the cordless handset into the telephone base.</li><li>5. Wait for the cordless handset to synchronize its connection with the telephone base. Allow up to one minute for this to take place.</li></ol></li></ul> |
|---------------------------------------|--|

## Important safety instructions



This symbol is to alert you to important operating or servicing instructions that may appear in this user's manual. Always follow basic safety precautions when using this product to reduce the risk of injury, fire, or electric shock.

### Safety information

---

- **Read and understand all instructions in the user's manual. Observe all markings on the product.**
- **Avoid using a telephone during a thunderstorm.** There may be a slight chance of electric shock from lightning.
- **Do not use a telephone in the vicinity of a gas leak.** If you suspect a gas leak, report it immediately, but use a telephone away from the area where gas is leaking. If this product is a cordless model, make sure the base is also away from the area.
- **Do not use this product near water, or when you are wet.** For example, do not use it in a wet basement or shower, or next to a swimming pool, bathtub, kitchen sink, or laundry tub. Do not use liquids or aerosol sprays for cleaning. If the product comes in contact with any liquids, unplug any line or power cord immediately. Do not plug the product back in until it has dried thoroughly.
- **Install this product in a protected location** where no one can trip over any line or power cords. Protect cords from damage or abrasion.
- **If this product does not operate normally, read Troubleshooting in this user's manual.** If you cannot solve the problem, or if the product is damaged, refer to the limited warranty. Do not open this product except as may be directed in your user's manual. Opening the product or reassembling it incorrectly may expose you to hazardous voltages or other risks.
- **If this product has user-replaceable batteries, replace batteries only as described in your user's manual.** Do not burn or puncture batteries — they contain caustic chemicals.
- **If this product has a three-prong (grounding) plug or a polarized plug with one wide prong,** it may not fit in non-polarized outlets. Do not defeat the purpose of these plugs. If they do not fit in your outlet, the outlet should be replaced by an electrician.



**CAUTION:** Use only the power adapter provided with this product. To obtain a replacement, visit our website at **[www.telephones.att.com](http://www.telephones.att.com)** or call **1 (800) 222-3111**. In Canada, dial **1 (866) 288-4268**.



## Important safety instructions

### Especially about cordless telephones

---

- **Privacy:** The same features that make a cordless telephone convenient create some limitations. Telephone calls are transmitted between the telephone base and handset by radio waves, so there is a possibility that your cordless telephone conversations could be intercepted by radio receiving equipment within range of the cordless handset. **For this reason, you should not think of cordless telephone conversations as being as private as those on corded telephones.**
- **Electrical power:** The telephone base of this cordless telephone must be connected to a working electrical outlet. The electrical outlet should not be controlled by a wall switch. **Calls cannot be made from the handset if the telephone base is unplugged or switched off, or if the electrical power is interrupted.**
- **Power adapter:** This power adapter is intended to be plugged into a vertical wall outlet or a floor outlet.
- **Potential TV interference:** Some cordless telephones operate at frequencies that may cause interference to TVs and VCRs. To minimize or prevent such interference, do not place the telephone base of the cordless telephone near or on top of a TV or VCR. If interference is experienced, moving the cordless telephone farther away from the TV or VCR will often reduce or eliminate the interference.
- **Rechargeable batteries:** This product contains either Nickel-Cadmium or Nickel-Metal Hydride rechargeable batteries. Exercise care in handling batteries in order not to short the battery with conducting material such as rings, bracelets, and keys. The battery or conductor may overheat and cause harm. Observe proper polarity between the battery and the battery charger.
- **Nickel-cadmium rechargeable batteries:** Must be recycled or disposed of properly. Do not dispose of in household garbage. Do not burn or puncture. Like other batteries of this type, if burned or punctured, they could release caustic material which could cause injury.



The RBRC™ Seal means that the manufacturer is voluntarily participating in an industry program to collect and recycle nickel-cadmium rechargeable batteries when taken out of service within the United States. These batteries may be taken to a participating local retailer of replacement batteries or recycling center. Or you may call 1 (800) 8-BATTERY for locations accepting spent nickel-cadmium batteries.

## Important safety instructions

### **Precautions for users of implanted cardiac pacemakers**

---

Cardiac pacemakers (applies only to digital cordless telephones):

Wireless Technology Research, LLC (WTR), an independent research entity, led a multidisciplinary evaluation of the interference between portable wireless telephones and implanted cardiac pacemakers. Supported by the U.S. Food and Drug Administration, WTR had recommended to physicians that:

### **Pacemaker patients**

---

- Should keep wireless telephones at least six inches from the pacemaker.
- Should NOT place wireless telephones directly over the pacemaker, such as in a breast pocket, when it is turned ON.
- Should use the wireless telephone at the ear opposite the pacemaker.

WTR's evaluation did not identify any risk to bystanders with pacemakers from other persons using wireless telephones.

### **Especially about telephones answering systems**

---

Two-way recording: This telephone does not sound warning beeps to let the other party know that the call is being recorded. To ensure that you are in compliance with any federal or state regulations regarding recording a telephone call, you should start the recording process and then inform the other party that you are recording the call.

## **SAVE THESE INSTRUCTIONS**

## FCC part 68 & ACTA

This equipment complies with Part 68 of the FCC rules and with technical requirements adopted by the Administrative Council for Terminal Attachments (ACTA). The label on the back or bottom of this equipment contains, among other things, a product identifier in the format US:AAAEQ##TXXXX. This identifier must be provided to your local telephone company upon request.

The plug and jack used to connect this equipment to premises wiring and the telephone network must comply with applicable Part 68 rules and technical requirements adopted by ACTA. A compliant telephone cord and modular plug is provided with this product. It is designed to be connected to a compatible modular jack that is also compliant. An RJ11 jack should normally be used for connecting to a single line and an RJ14 jack for two lines. See Installation Instructions in the user's manual.

The Ringer Equivalence Number (REN) is used to determine how many devices you may connect to your telephone line and still have them ring when you are called. The REN for this product is encoded as the 6th and 7th characters following the US: in the product identifier (e.g., if ## is 03, the REN is 0.3). In most, but not all areas, the sum of all RENs should be five (5.0) or less. For more information, please contact your local telephone company.

This equipment may not be used with Party Lines. If you have specially wired alarm dialing equipment connected to your telephone line, ensure the connection of this equipment does not disable your alarm equipment. If you have questions about what will disable alarm equipment, consult your telephone company or a qualified installer.

If this equipment is malfunctioning, it must be unplugged from the modular jack until the problem has been corrected. Repairs to this telephone equipment can only be made by the manufacturer or its authorized agents. For repair procedures, follow the instructions outlined under the Limited Warranty.

If this equipment is causing harm to the telephone network, the telephone company may temporarily discontinue your telephone service. The telephone company is required to notify you before interrupting service. If advance notice is not practical, you will be notified as soon as possible. You will be given the opportunity to correct the problem and the telephone company is required to inform you of your right to file a complaint with the FCC. Your telephone company may make changes in its facilities, equipment, operation, or procedures that could affect the proper functioning of this product. The telephone company is required to notify you if such changes are planned.

## FCC part 68 & ACTA

If this product is equipped with a corded or cordless handset, it is hearing aid compatible.

If this product has memory dialing locations, you may choose to store emergency telephone numbers (e.g., police, fire, medical) in these locations. If you do store or test emergency numbers, please:

Remain on the line and briefly explain the reason for the call before hanging up.

Perform such activities in off-peak hours, such as early morning or late evening.

### **Industry Canada**

Operation is subject to the following two conditions: (1) this device may not cause harmful interference, and (2) this device must accept any interference, including interference that may cause undesired operation.

The term "IC:" before the certification/registration number only signifies that the Industry Canada technical specifications were met.

The Ringer Equivalence Number (REN) for this terminal equipment is 0.1. The REN is an indication of the maximum number of devices allowed to be connected to a telephone interface. The termination on an interface may consist of any combination of devices subject only to the requirement that the sum of the RENs of all the devices does not exceed five.

This product meets the applicable Industry Canada technical specifications.

## FCC part 15

This equipment has been tested and found to comply with the requirements for a Class B digital device under Part 15 of the Federal Communications Commission (FCC) rules. These requirements are intended to provide reasonable protection against harmful interference in a residential installation. This equipment generates, uses and can radiate radio frequency energy and, if not installed and used in accordance with the instructions, may cause harmful interference to radio communications. However, there is no guarantee that interference will not occur in a particular installation. If this equipment does cause harmful interference to radio or television reception, which can be determined by turning the equipment off and on, the user is encouraged to try to correct the interference by one or more of the following measures:

- Reorient or relocate the receiving antenna.
- Increase the separation between the equipment and receiver.
- Connect the equipment into an outlet on a circuit different from that to which the receiver is connected.
- Consult the dealer or an experienced radio/TV technician for help.

Changes or modifications to this equipment not expressly approved by the party responsible for compliance could void the user's authority to operate the equipment.

This device complies with Part 15 of the FCC Rules. Operation is subject to the following two conditions: (1) this device may not cause harmful interference, and (2) this device must accept any interference received, including interference that may cause undesired operation. Privacy of communications may not be ensured when using this telephone.

To ensure safety of users, the FCC has established criteria for the amount of radio frequency energy that can be safely absorbed by a user or bystander according to the intended usage of the product. This product has been tested and found to comply with the FCC criteria. The handset may be safely held against the ear of the user. The telephone base shall be installed and used such that parts of the user's body other than the hands are maintained at a distance of approximately 20 cm (8 inches) or more. If you choose to use a clipping device, please make sure to only use the supplied AT&T belt clip.

This Class B digital apparatus complies with Canadian ICES-003.

## Limited warranty

The AT&T brand is used under license - any repair, replacement or warranty service, and all questions about this product should be directed to: In the United States of America, visit our website at **www.telephones.att.com** or call **1 (800) 222-3111**. In Canada, dial **1 (866) 288-4268**.

### 1. What does this limited warranty cover?

The manufacturer of this AT&T-branded product warrants to the holder of a valid proof of purchase (“CONSUMER” or “you”) that the product and all accessories provided in the sales package (“PRODUCT”) are free from defects in material and workmanship, pursuant to the following terms and conditions, when installed and used normally and in accordance with the PRODUCT operating instructions. This limited warranty extends only to the CONSUMER for products purchased and used in the United States of America and Canada.

### 2. What will be done if the PRODUCT is not free from defects in materials and workmanship during the limited warranty period (“materially defective PRODUCT”)?

During the limited warranty period, the manufacturer’s authorized service representative will repair or replace at the manufacturer’s option, without charge, a materially defective PRODUCT. If the manufacturer repairs the PRODUCT, they may use new or refurbished replacement parts. If the manufacturer chooses to replace the PRODUCT, they may replace it with a new or refurbished PRODUCT of the same or similar design. The manufacturer will retain defective parts, modules, or equipment. Repair or replacement of the PRODUCT, at the manufacturer’s option, is your exclusive remedy. The manufacturer will return repaired or replacement products to you in working condition. You should expect the repair or replacement to take approximately 30 days.

### 3. How long is the limited warranty period?

The limited warranty period for the PRODUCT extends for ONE (1) YEAR from the date of purchase. If the manufacturer repairs or replaces a materially defective PRODUCT under the terms of this limited warranty, this limited warranty also applies to repaired or replacement PRODUCT for a period of either (a) 90 days from the date the repaired or replacement PRODUCT is shipped to you or (b) the time remaining on the original one-year limited warranty; whichever is longer.

## Limited warranty

### 4. What is not covered by this limited warranty?

This limited warranty does not cover:

- PRODUCT that has been subjected to misuse, accident, shipping or other physical damage, improper installation, abnormal operation or handling, neglect, inundation, fire, water, or other liquid intrusion; or
- PRODUCT that has been damaged due to repair, alteration, or modification by anyone other than an authorized service representative of the manufacturer; or
- PRODUCT to the extent that the problem experienced is caused by signal conditions, network reliability or cable or antenna systems; or
- PRODUCT to the extent that the problem is caused by use with non-AT&T accessories; or
- PRODUCT whose warranty/quality stickers, PRODUCT serial number plates or electronic serial numbers have been removed, altered or rendered illegible; or
- PRODUCT purchased, used, serviced, or shipped for repair from outside the United States of America or Canada, or used for commercial or institutional purposes (including but not limited to products used for rental purposes); or
- PRODUCT returned without valid proof of purchase (see item 6 below); or
- Charges for installation or setup, adjustment of customer controls, and installation or repair of systems outside the telephone.

### 5. How do you get warranty service?

To obtain warranty service in the United States of America, call **1 (800) 222-3111**; In Canada, please dial **1 (866) 288-4268**.

NOTE: Before calling for service, please review the user's manual - a check of the PRODUCT controls and features may save you a service call.

Except as provided by applicable law, you assume the risk of loss or damage during transit and transportation and are responsible for delivery or handling charges incurred in the transport of the PRODUCT(s) to the service location. The manufacturer will return repaired or replaced PRODUCT under this limited warranty. Transportation, delivery or handling charges are prepaid. The manufacturer assumes no risk for damage or loss of the PRODUCT in transit. If the PRODUCT failure is not covered by this limited warranty, or proof of purchase does not meet the terms of this limited warranty, the manufacturer will notify you and will request that you authorize the cost of repair prior to any further repair activity. You must pay for the cost of repair and return shipping costs for the repair of products that are not covered by this limited warranty.

## Limited warranty

### 6. What must you return with the PRODUCT to get warranty service?

You must:

- a. Return the entire original package and contents including the PRODUCT to the service location along with a description of the malfunction or difficulty; and
- b. Include “valid proof of purchase” (sales receipt) identifying the PRODUCT purchased (PRODUCT model) and the date of purchase or receipt; and
- c. Provide your name, complete and correct mailing address, and telephone number.

### 7. Other limitations

This warranty is the complete and exclusive agreement between you and the manufacturer of this AT&T branded PRODUCT. It supersedes all other written or oral communications related to this PRODUCT. The manufacturer provides no other warranties for this PRODUCT. The warranty exclusively describes all of the manufacturer’s responsibilities regarding the PRODUCT. There are no other express warranties. No one is authorized to make modifications to this limited warranty and you should not rely on any such modification.

**State/Provincial Law Rights:** This warranty gives you specific legal rights, and you may also have other rights which vary from state to state or province to province.

**Limitations:** Implied warranties, including those of fitness for a particular purpose and merchantability (an unwritten warranty that the PRODUCT is fit for ordinary use) are limited to one year from date of purchase. Some states/provinces do not allow limitations on how long an implied warranty lasts, so the above limitation may not apply to you. In no event shall the manufacturer be liable for any indirect, special, incidental, consequential, or similar damages (including, but not limited to lost profits or revenue, inability to use the PRODUCT or other associated equipment, the cost of substitute equipment, and claims by third parties) resulting from the use of this PRODUCT. Some states/provinces do not allow the exclusion or limitation of incidental or consequential damages, so the above limitation or exclusion may not apply to you.

**Please retain your original sales receipt as proof of purchase.**



## Technical specifications

<b>RF frequency band (handset to telephone base)</b>	5857.2 MHz — 5865.9 MHz
<b>RF frequency band (telephone base to handset)</b>	912.75 MHz — 917.10 MHz
<b>Channels</b>	30
<b>Modulation</b>	FM
<b>Operating temperature</b>	32°F — 122°F 0°C — 50°C
<b>Telephone base voltage (AC voltage, 60Hz)</b>	104 — 129Vrms
<b>Telephone base voltage (AC adapter output)</b>	AC7.5V @350mA
<b>Charger voltage (AC adapter output)</b>	AC7.5V @150mA
<b>Handset voltage</b>	DC3.1 — 4.3V 400mAh
<b>Replacement battery</b>	3.6V 400mAh Ni-Cd

### 5.8 GHz analog technology

Dual band transmission combines the best of 5.8 GHz and 900MHz analog technologies to provide quality performance and complete signal coverage for a standard home, while not interfering with wireless routers.

### Telephone operating range

This cordless telephone operates with the maximum power allowed by the Federal Communications Commission (FCC). Even so, the handset and telephone base can communicate over only a certain distance - which can vary with the locations of the telephone base and handset, the weather, the layout, and the construction of your home or office.

# Index

## A

---

Alert tones, 42  
Answer a call, 14  
Answering system, 33-41

## B

---

Battery charging, 9  
Battery installation, 9  
Battery low, 10

## C

---

Call waiting, 17  
Caller ID, 27  
    add entries to the directory, 32  
    delete entries, 31  
    dial entries, 30  
Channel, 17  
Call screening, 40  
Call intercept, 40  
Call transfer, 18-20

## D

---

Delete call history entries, 31  
Delete redial entries, 15  
Dialing,  
    directory dialing, 26  
    from a CID record, 30  
    mode, 11  
Directory, 21  
    dial number, 26  
    edit entries, 26  
    search, 25  
DSL filter, 6

## E

---

Elapsed time, 14

## H

---

Handset locator, 16  
Home area code, 13

## I

---

Incoming call history, 30  
Incoming calls, answering, 14  
Indicator lights, 42

## L

---

Language, 11

## M

---

Make a call, 14  
Message playback, 37  
Missed calls, 29  
Mute, 17

## N

---

New calls, 29

## P

---

Power adapter, 6  
Predialing, 14

## Q

---

Quick reference guide, 2-3

## R

---

Recharging, 9  
Redial, 15  
Ring silencing, 15  
Ringer, 12  
Ringer volume, 12

## S

---

Screen display messages, 43-44  
Search for names, 25  
Speed dial, 22

## T

---

Technical specifications, 61  
Temporary tone dialing, 17  
Troubleshooting, 45-51

## V

---

Volume control,  
    Ringer, 12  
    Telephone, 17  
Voice prompts, 33

# Remote access wallet card

Use the wallet card below to help you remember commands to control your answering system from any touch tone telephone.

Cut along dotted line.



Call your phone number, then enter your two-digit access code (preset to **19**).

Action	Remote command
--------	----------------

- |                               |           |
|-------------------------------|-----------|
| Play all messages .....       | <b>1</b>  |
| Play new messages.....        | <b>2</b>  |
| Delete the message.....       | <b>3</b>  |
| Delete all old messages ..... | <b>33</b> |
| Repeat or go back.....        | <b>4</b>  |
| Stop.....                     | <b>5</b>  |
| Help menu .....               | <b>*5</b> |

Fold here.

- |                              |                       |
|------------------------------|-----------------------|
| Skip the message.....        | <b>6</b>              |
| Record announcement .....    | <b>*7</b>             |
| Turn system off or on .....  | <b>0</b>              |
| End remote access call ..... | <b>8</b> (or hang up) |

**EL42208/EL42308/EL42408/EL42258**  
**5.8 GHz cordless telephone/answering system**

© 2008-2009 Advanced American Telephones. All Rights Reserved. AT&T and the AT&T logo are trademarks of AT&T Intellectual Property licensed to Advanced American Telephones, San Antonio, TX 78219. Printed in China.



Proud Sponsor

[www.telephones.att.com](http://www.telephones.att.com)