



User's manual

CL4940

Big button/big display telephone/
answering system with caller ID/
call waiting



Congratulations

on your purchase of this AT&T product. Before using this AT&T product, please read the **Important safety information** section on page 52 of this manual. Please thoroughly read this user's manual for all the feature operations and troubleshooting information necessary to install and operate your new AT&T product. You can also visit our website at www.telephones.att.com or call **1 (800) 222-3111**. In Canada, dial **1 (866) 288-4268**.

Model number: CL4940

Type: Big button/big display telephone/answering system with caller ID/call waiting

Serial number: _____

Purchase date: _____

Place of purchase: _____

Both the model and serial numbers of your AT&T product can be found on the bottom of the telephone base.

Save your sales receipt and original packaging in case it is necessary to return your telephone for warranty service.



Telephones identified with this logo have reduced noise and interference when used with most T-coil equipped hearing aids and cochlear implants. The TIA-1083 Compliant Logo is a trademark of the Telecommunications Industry Association. Used under license.

Parts checklist

Your telephone package contains the following items. Save your sales receipt and original packaging in the event warranty service is necessary.



Telephone base with power adapter installed



Handset

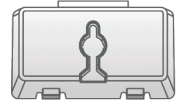

Wall-mount bracket

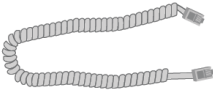

Coiled handset cord



Telephone line cord

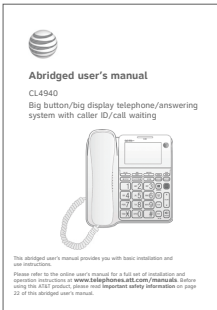

Abridged user's manual

User's manual

CL4940

Big button/big display telephone/
answering system with caller ID/
call waiting



Table of contents

Getting started

| | |
|----------------------------------------------|---|
| Quick reference guide | 1 |
| Installation | 3 |
| Telephone installation | 4 |
| Installation options..... | 6 |
| Tabletop to wall-mount installation | 6 |
| Wall-mount to tabletop installation | 8 |

Telephone settings

| | |
|--------------------------|----|
| Telephone settings | 10 |
| Set date/time | 10 |
| Ringer volume | 11 |
| Language | 11 |
| LCD contrast..... | 12 |
| Dial mode | 12 |

Telephone operation

| | |
|-----------------------------------------------------|----|
| Line power mode (no AC power)... | 13 |
| To make a call during a power failure | 13 |
| To answer a call during a power failure | 13 |
| Telephone operation | 14 |
| Making a call..... | 14 |
| On hook dialing (predialing)..... | 14 |
| Answering a call..... | 14 |
| Switching between handset and speakerphone | 14 |

| | |
|------------------------------|----|
| Ending a call..... | 14 |
| Last number redial | 15 |
| Equalizer | 15 |
| Options while on calls | 16 |
| Volume control | 16 |
| Call waiting | 16 |
| Mute..... | 16 |
| Chain dialing | 17 |
| Audio Assist® | 18 |
| Temporary tone dialing | 18 |

Directory

| | |
|---------------------------------------------------------------------------|----|
| Directory | 19 |
| Directory memory capacity..... | 19 |
| Character chart..... | 19 |
| Create a new directory entry | 19 |
| Review directory entries | 20 |
| Search by name..... | 21 |
| Display dial..... | 22 |
| Delete a directory entry | 22 |
| Edit a directory entry | 22 |
| Speed dial | 23 |
| Enter a speed dial number | 23 |
| Assign a speed dial number from the directory or caller ID log..... | 24 |
| Delete a speed dial number..... | 24 |
| Review a speed dial number..... | 25 |
| Dial a speed dial number..... | 25 |

| | |
|----------------------------------------------------------|----|
| Caller ID | |
| About caller ID | 26 |
| Information about caller ID with call waiting | 26 |
| Caller ID history | 27 |
| How the caller ID history (caller ID log) works | 27 |
| Missed (new) call indicator | 27 |
| Caller ID operation | 28 |
| Memory match | 28 |
| Review the caller ID history | 29 |
| View dialing options | 30 |
| Dial a caller ID log entry | 30 |
| Delete caller ID log entries | 30 |
| Save a caller ID log entry to the directory | 31 |
| Set area code | 32 |
| Reasons for missing caller ID information | 33 |

Answering system

| | |
|-------------------------------------------------|----|
| Answering system settings | 34 |
| Announcement | 34 |
| To turn on or off the answering system | 35 |
| Number of rings | 36 |
| Call screening | 36 |
| Message alert | 37 |
| Remote code | 37 |
| Priority code | 38 |
| About the answering system | 39 |
| Message capacity | 39 |
| Voice prompts | 39 |
| Call screening | 39 |
| Call intercept | 39 |
| Message Guard® | 39 |
| Message playback | 40 |
| Options during playback | 40 |
| Delete all old messages | 40 |
| Memo | 41 |

| | |
|--------------------------------|----|
| Message counter displays | 42 |
| Remote access | 43 |

Appendix

| | |
|------------------------------------|----|
| Screen icons and alert tones | 44 |
| Screen icons | 44 |
| Alert tones | 44 |
| Lights | 45 |
| Indicator lights | 45 |
| Display screen messages | 46 |
| Screen messages | 46 |
| Troubleshooting | 47 |
| Maintenance | 51 |
| Important safety information | 52 |
| FCC and ACTA information | 53 |
| Part 15 of FCC rules | 55 |
| Limited warranty | 56 |
| Technical specifications | 58 |

Index

| | |
|-------------|----|
| Index | 59 |
|-------------|----|

Quick reference guide

MENU/SELECT

Press in idle mode to enter the main menu (page 10).
While in the menu, press to confirm or save an entry or setting.
Press to select a highlighted item.

CALL LOG ▼

Press to display the caller ID history (page 29).
Press to scroll down while in menus or lists.
While entering names or numbers, press to move the cursor to the left.

◀ REPEAT

During message playback, press to repeat the message currently playing (page 40).
During message playback, press twice to play the previous message (page 40).
Press in idle mode to record a memo (page 41).

PLAY/STOP/■

Press to start or stop message playback (page 40).

DIRECTORY ▲

Press to display the directory (page 20).
Press to scroll up while in menus or lists.
While entering names or numbers, press to move the cursor to the right.

CANCEL

While in a menu, press to cancel an operation, back up to the previous menu or exit the menu display.
Press and hold to reset the missed calls and new message alert (page 27).

REDIAL/PAUSE

Press to display the last number dialed (page 15).
While using the handset or speakerphone, press to dial the last number dialed (page 15).
While entering numbers, press to insert a three-second dialing pause. (pages 22, 23, and 31).
While storing numbers in the speed dial memory or directory, press to copy the last number dialed before entering any numbers (pages 19 and 23).

DELETE X

While reviewing the redial history, directory, or caller ID history, press to delete the displayed entry (pages 15, 22 and 30, respectively).
During playback, press to delete a message or announcement (pages 40 and 35).
Press twice in idle mode to delete all old messages (page 40).
Press to delete digits or characters when entering numbers or names.

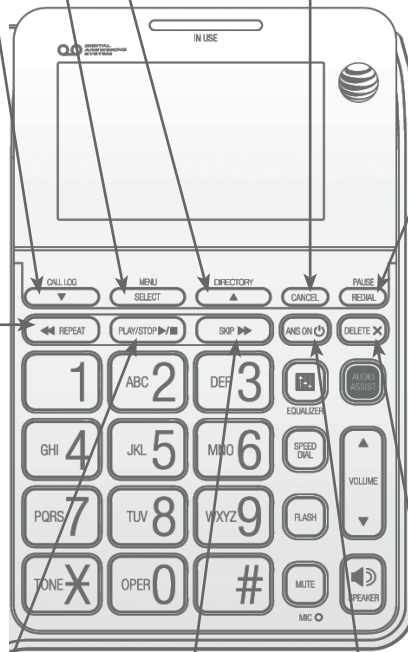

SKIP ►

Press to skip a message during message playback (page 40).

ANS ON Ⓞ

Press to turn the answering system on or off (page 35).

Quick reference guide

EQ/EQUALIZER

During an outside call, message or announcement playback, press to change the audio quality to best suit your hearing (page 15).

SPEED DIAL

Press in idle mode to display the speed dial list (page 25).

FLASH

Press to put your current call on hold and take the new call when you receive a call waiting alert (page 16).

TONEX

Press to switch to tone dialing temporarily during a call if you have pulse service (page 18).

When reviewing directory entries, press to move towards the end of the telephone number (page 20).

(pound key)

When reviewing directory entries, press to move towards the beginning of the telephone number (page 20).

Press repeatedly to display other dialing options when reviewing a caller ID log entry (page 30).

MUTE

During a call, press to mute the microphone. Press again to resume your conversation (page 16).

MIC

Microphone.

Extra large tilt display

Move the top of the display forward or backward to adjust the angle of the screen for maximum visibility.

AUDIO ASSIST®

Voices will sound louder and clearer if you press **AUDIO ASSIST®** while you are on a call using the handset (page 18).

▲ VOLUME ▼

During message playback or call screening, press to adjust the listening volume (pages 40 and 39).

While in idle mode, press to adjust the base ringer volume (page 11).

While on a call, press to adjust the listening volume (page 16).

▶ SPEAKER

Press to make or answer a call using the speakerphone (page 14).

Press to switch between speakerphone and handset (page 14).

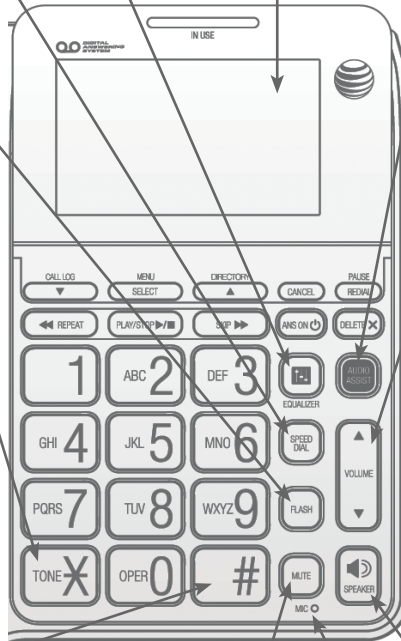

Installation

You must install the power adapter before using the telephone.



See pages 4-5 for easy instructions.

Install the telephone base close to a telephone jack and a power outlet not controlled by a wall switch. The telephone base can be placed on a flat surface or vertically mounted on the wall (see pages 6-9).

If you subscribe to high-speed Internet service (DSL - digital subscriber line) through your telephone line, you must install a DSL filter between the telephone line cord and the telephone wall jack (see page 4). The filter prevents noise and caller ID problems caused by DSL interference. Please contact your DSL service provider for more information about DSL filters.

Your product may be shipped with a protective sticker covering the telephone base display, remove it before use.

For customer service or product information, visit our website at www.telephones.att.com or call **1 (800) 222-3111**. In Canada, dial **1 (866) 288-4268**.

Avoid placing the telephone base too close to:

- Communication devices such as television sets, VCRs, or cordless telephones.
- Excessive heat sources.
- Noise sources such as a window with traffic outside, motors, microwave ovens, refrigerators, or fluorescent lighting.
- Excessive dust sources such as a workshop or garage.
- Excessive moisture.
- Extremely low temperature.
- Mechanical vibration or shock such as on top of a washing machine or work bench.

Telephone installation

Install the telephone, as shown below.

The telephone is ready for tabletop use. If you want to change to wall-mounting, see **Installation options** on page 6 for details.

1. Plug one end of the coiled handset cord into the handset jack on the left side of the telephone base. Plug the other end into the jack on the bottom of the handset.

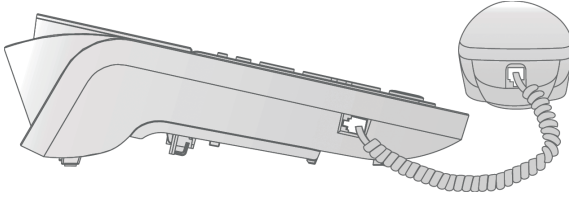

2. Plug one end of the telephone line cord into the telephone line jack on the bottom of the telephone base. Route the telephone line cord through the slot. Plug the other end of the telephone line cord into a telephone wall jack or a DSL filter.
3. Plug the power adapter into an electrical outlet not controlled by a wall switch.

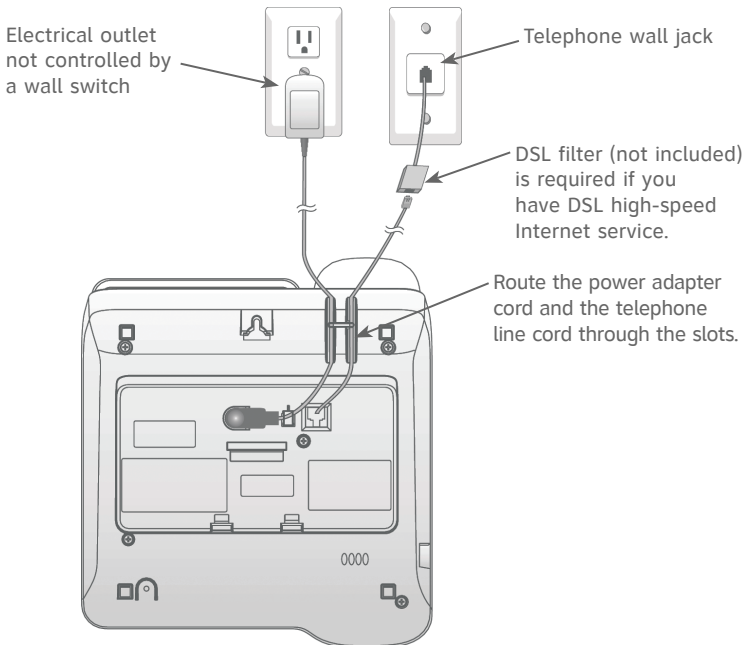

Telephone installation

4. Adjust the angle of the screen to reach maximum visibility.

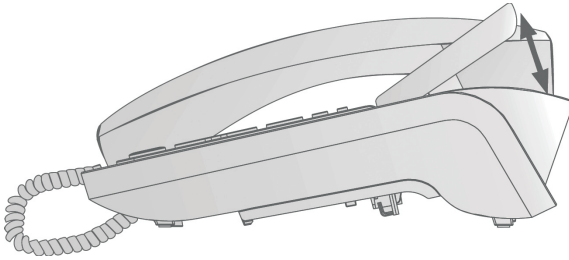

NOTES:

- Use only the power adapter provided with this product. To obtain a replacement, visit our website at www.telephones.att.com or call **1 (800) 222-3111**. In Canada, dial **1 (866) 288-4268**.
- The power adapter is intended to be correctly oriented in a vertical or floor mount position. The prongs are not designed to hold the plug in place if it is plugged into a ceiling, under-the-table or cabinet outlet.
- You can use this telephone without the power adapter installed. See **Line power mode** on page 13.
- After you first install your telephone, the system will prompt you to set the date and time, and outgoing announcement.

Installation options

If you want to mount your telephone on a wall, use the provided wall-mount bracket to connect with a standard dual-stud telephone wall-mounting plate. If you do not have this mounting plate, you can purchase one from many hardware or consumer electronics retailers. Professional assistance may be required to install the mounting plate.

Tabletop to wall-mount installation

To install the telephone base in the wall-mount position, make sure you first unplug the power adapter cord and telephone line cord from the telephone base and wall outlets.

1. Lift the handset and place it aside. Hold down the switch hook on the telephone base, then slide the handset tab upwards to remove it from the slot. Rotate the handset tab 180 degrees. Push the handset tab down into the slot so it locks into position.

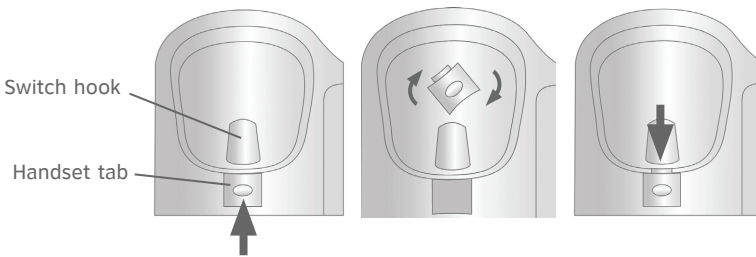

2. Align the tabs on the wall-mount bracket to the slots at the back of the telephone base. Insert tab **A** on the top into its corresponding slot and click tabs **B** into their corresponding slots.

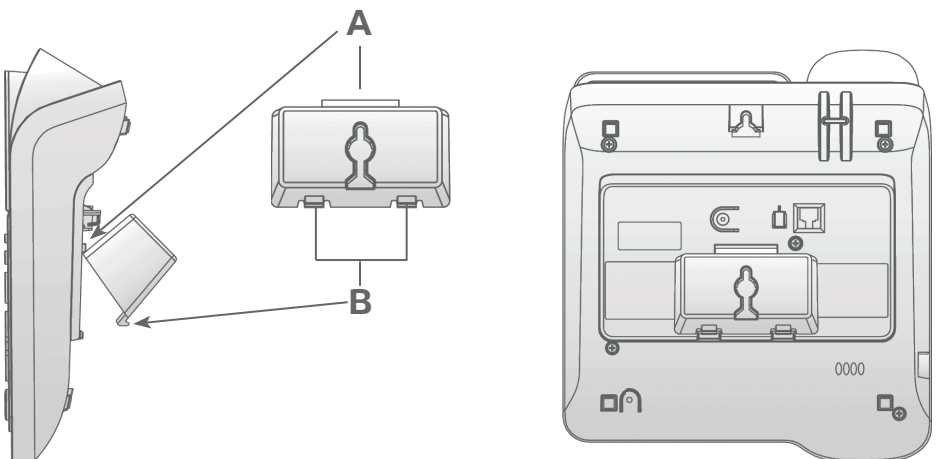

Installation options

3. Plug one end of the telephone line cord into the telephone line jack on the bottom of the telephone base. Plug the other end into a telephone wall jack or a DSL filter. Bundle the telephone line cord and secure it with a twist tie.
4. Plug the power adapter into an electrical outlet not controlled by a wall switch.

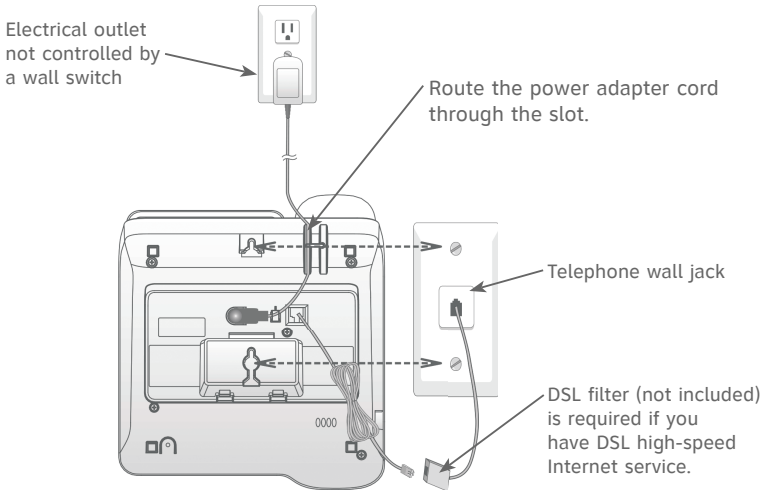

5. Place the telephone just above the studs on the wall-mounting plate. Slide the telephone down until it is held securely on the wall-mounting plate. Place the handset on the telephone base.

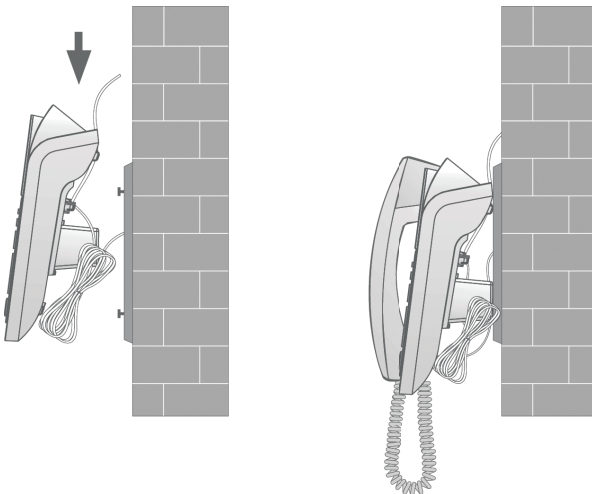

6. Adjust the screen angle for maximum visibility.

Installation options

Wall-mount to tabletop installation

To change the telephone base from the wall-mount position to tabletop position, follow the steps.

1. Slide the telephone base upwards, then remove the telephone from the wall-mounting plate.

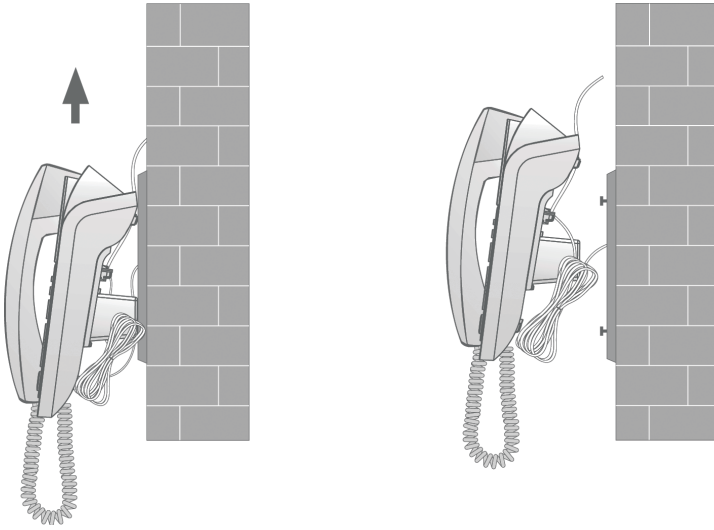

2. Unplug the large end of the power adapter from the electrical outlet. Remove the power adapter cord from the slot. Unplug the smaller end from the power jack on the bottom of the telephone base. Unplug the telephone line cord from the wall jack and the telephone base. Untie the bundled telephone line cord.
3. Lift the handset and place it aside. Hold down the switch hook on the telephone base, then slide the handset tab upwards to remove it from the slot. Rotate the handset tab 180 degrees. Push the handset tab down into the slot so it clicks into position.

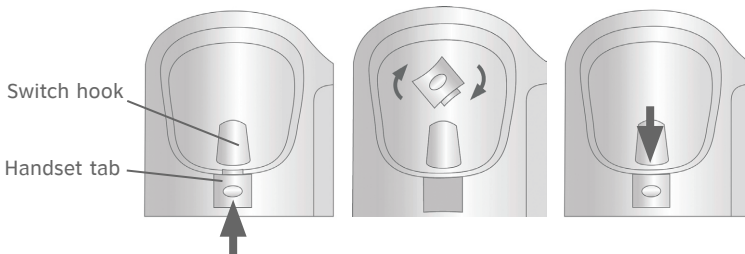

Installation options

4. Push the two tabs at the bottom of the wall-mount bracket, as indicated, and remove the wall-mount bracket from the telephone.

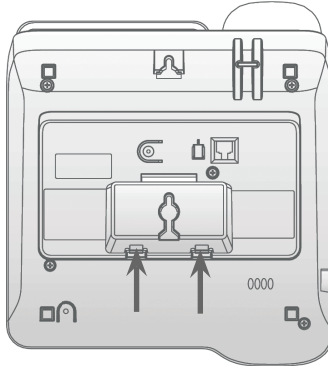

5. Plug one end of the telephone line cord into the telephone line jack on the bottom of the telephone base. Plug the other end into a telephone wall jack or a DSL filter. Plug the small end of the power adapter into the power jack on the bottom of the telephone base. Plug the large end into an electrical outlet not controlled by a wall switch. Route both cords through the slots.

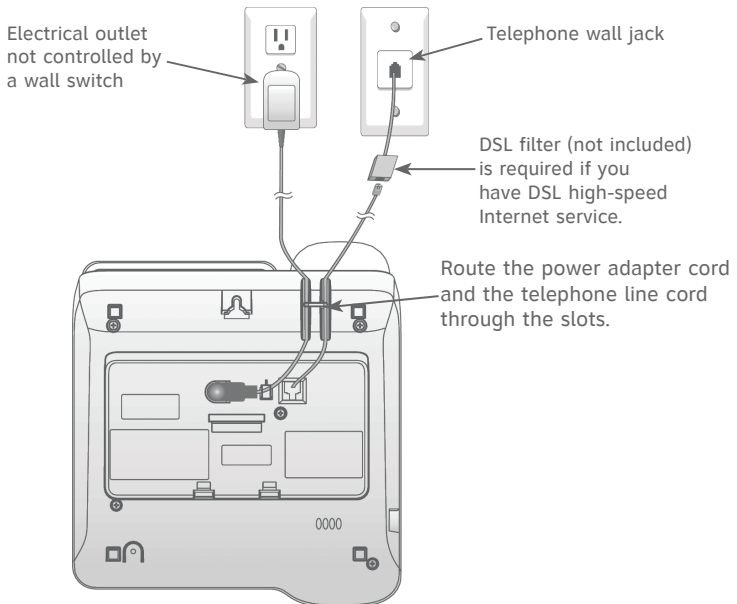

6. Adjust the screen angle for maximum visibility.

Telephone settings

Use the menu to change the telephone settings:

1. Press **MENU/SELECT** on the telephone when it is not in use to enter the main menu.
2. Press **CALL LOG** ▼ or **DIRECTORY** ▲ to scroll to the feature to be changed. When scrolling through the menu, the > symbol indicates the selected menu item.
3. Press **MENU/SELECT** to select the highlighted item.



NOTE: Press **CANCEL** to cancel an operation, back up to the previous menu or exit the menu display. Press and hold **CANCEL** to return to idle mode.

Set date/time

The answering system announces the day and time of each message prior to playing it. Before using the answering system, set the date and time as follows. If you subscribe to caller ID service, the day, month and time are set automatically with each incoming call. The year must be set so that the day of the week can be calculated from the caller ID information.

To set the date and time manually:

1. When the telephone base is in idle mode, press **MENU/SELECT** to enter the main menu.
2. Press **CALL LOG** ▼ or **DIRECTORY** ▲ to scroll to **Set date/time** and then press **MENU/SELECT**.
3. Press **CALL LOG** ▼ or **DIRECTORY** ▲ to select the month, then press **MENU/SELECT**, or enter the number using the dialing keys.
4. Press **CALL LOG** ▼ or **DIRECTORY** ▲ to select the day, then press **MENU/SELECT**, or enter the number using the dialing keys.
5. Press **CALL LOG** ▼ or **DIRECTORY** ▲ to select the year, then press **MENU/SELECT**, or enter the number using the dialing keys, then press **MENU/SELECT** to move on to set the time.
6. Press **CALL LOG** ▼ or **DIRECTORY** ▲ to select the hour, then press **MENU/SELECT**, or enter the number using the dialing keys.
7. Press **CALL LOG** ▼ or **DIRECTORY** ▲ to select the minute, then press **MENU/SELECT**, or enter the number using the dialing keys.
8. Press **CALL LOG** ▼ or **DIRECTORY** ▲ to highlight **AM** or **PM**, or press **2** for **AM** or **7** for **PM**. Then, press **MENU/SELECT** to confirm. There is a confirmation tone and the screen returns to the previous menu.

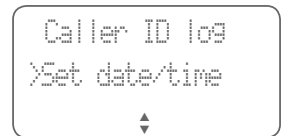

NOTES:

- If you want to make correction, press **CANCEL** to go back to the previous field.
- If the clock is not set when a message is recorded, the system announces, "Time and day not set," before it plays the message

Telephone settings

Ringer volume

You can set the ringer volume level to one of four levels or turn the ringer off. When the ringer is off,  appears on the screen.

Press **▲VOLUME▼** when the telephone is not in use.

-OR-

1. Press **MENU/SELECT** in idle mode to enter the main menu.
2. Use **CALL LOG▼** or **DIRECTORY▲** to scroll to **Ringer volume**, then press **MENU/SELECT**.
3. Press **CALL LOG▼** or **DIRECTORY▲**, or **▲VOLUME▼** to sample each volume level.
4. Press **MENU/SELECT** to save your preference. There is a confirmation tone and the screen returns to the previous menu.

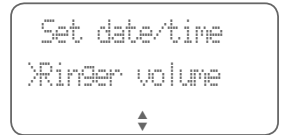

NOTES:

- If the ringer volume is set to off, the telephone base is silenced for all incoming calls.
- You can temporarily adjust the ringer volume when the telephone is ringing. The next incoming call rings at the preset volume.

Language

You can select the language used for all screen displays and voice prompts.

1. Press **MENU/SELECT** in idle mode to enter the main menu.
2. Use **CALL LOG▼** or **DIRECTORY▲** to scroll to **Language**, then press **MENU/SELECT**.
3. Press **CALL LOG▼** or **DIRECTORY▲** to highlight **English**, **Français** or **Español**.
4. Press **MENU/SELECT**. The screen displays a confirmation message.
5. Press **MENU/SELECT** again to confirm. There is a confirmation tone and the screen returns to the previous menu.



Telephone settings

LCD contrast

You can set the contrast of the screen to one of four levels.

1. Press **MENU/SELECT** in idle mode to enter the main menu.
2. Use **CALL LOG**▼ or **DIRECTORY**▲ to scroll to **LCD contrast**, then press **MENU/SELECT**.
3. Press **CALL LOG**▼ or **DIRECTORY**▲ to choose from **1**, **2**, **3** or **4**.
4. Press **MENU/SELECT** to save your preference. There is a confirmation tone and the screen returns to the previous menu.



Dial mode

The dial mode is preset to touch-tone dialing. If you have pulse (rotary) service, you must change the dial mode to pulse dialing before using the telephone.

To set the dial mode:

1. Press **MENU/SELECT** in idle mode to enter the main menu.
2. Use **CALL LOG**▼ or **DIRECTORY**▲ to scroll to **Dial mode**, then press **MENU/SELECT**.
3. Use **CALL LOG**▼ or **DIRECTORY**▲ to highlight **Touch tone** or **Pulse**, then press **MENU/SELECT**. There is a confirmation tone and the screen returns to the previous menu.

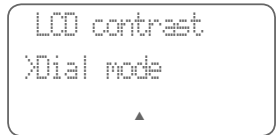

Line power mode (no AC power)

This telephone provides minimal functionality during a power failure. When AC power is not available, the screen is blank and many telephone features do not function. Only touch-tone dialing and handset volume adjustment are supported. The telephone uses power from the telephone line to enable you to make and answer calls using only the handset and dialing keys.

To make a call during a power failure

1. Lift the handset and wait for the dial tone. The screen shows **NO AC POWER**.
2. Dial a telephone number using the dialing keys. Wait to hear each key tone and make sure the digit appears on the screen before pressing the next dialing key.

To answer a call during a power failure

- Lift the handset.



NOTE: The screen does not show incoming caller ID information during a power failure.

Telephone operation

Making a call

Lift the handset or press **SPEAKER**, then enter the telephone number.

The screen displays the elapsed time as you talk (in hours, minutes and seconds).



On hook dialing (predialing)

1. Enter the telephone number. Press **DELETE X** to make corrections when entering the telephone number.
2. Lift the handset or press **SPEAKER**.

Answering a call

- Lift the handset or press **SPEAKER**.

Switching between handset and speakerphone

To switch from handset to speakerphone during a call:

- Press **SPEAKER**, then place the handset in the telephone base.

To switch from speakerphone to handset during a call:

- Lift the handset.

Ending a call

Press **SPEAKER**, or place the handset in the telephone base.

Telephone operation

Last number redial

The telephone stores the last telephone number dialed (up to 32 digits).

To redial a number:

1. To display the most recently called number, press **REDIAL/PAUSE** when the telephone is not in use.
2. Lift the handset or press **SPEAKER** to call.



-OR-

1. Lift the handset or press **SPEAKER**.
2. Press **REDIAL/PAUSE** to dial the number.

To delete a redial entry:

- While the screen displays the redial number, press **DELETE X** to delete the number from the redial memory. The screen shows **Deleted** with a confirmation tone.



NOTES:

- The screen shows only the last 15 digits if the number has more than 15 digits.
- If the redial list is empty, you will see **Redial empty** on the screen and hear an error tone when you press **REDIAL/PAUSE**.

Equalizer

The telephone equalizer enables you to change the quality of the audio to best suit your hearing.

While on a call, or listening to a message or announcement, press **EQ/EQUALIZER** to one of the four equalizer settings, **Natural** (default setting), **Treble 1**, **Treble 2** or **Bass**. The screen shows **EQ changed to Natural**, **EQ changed to Treble 1**, **EQ changed to Treble 2** or **EQ changed to Bass**, respectively. The current setting shows on the screen for 2 seconds.



NOTES:

- The current equalizer setting remains unchanged until a new setting is selected.
- If you press **EQ/EQUALIZER** in idle mode, the telephone shows **To change EQ set during call** with an error tone.

Options while on calls

Volume control

You can set the listening volume to one of five levels. While on a call, press **▲VOLUME▼** to adjust the listening volume. The volume level indicator briefly displays on the screen to indicate the setting.

Handset volume

When you are on a call using the handset, press **▼VOLUME** to decrease or **VOLUME▲** to increase the handset listening volume.



Speaker volume

When you are on a call using the speakerphone, press **▼VOLUME** to decrease or **VOLUME▲** to increase the speaker volume.



Call waiting

If you subscribe to call waiting service from your telephone service provider, and someone calls while you are already on a call, you hear two beeps.

- Press **FLASH** to put your current call on hold and take the new call.
- Press **FLASH** at any time to switch back and forth between calls.



NOTE: Missed call waiting calls are counted as missed calls.

Mute

Use the mute function to turn off the microphone. You can hear the caller, but the caller cannot hear you.

To mute a call:

- While on a call, press **MUTE**. When mute is on, the **MUTE** light turns on.

To end mute a call:

- Press **MUTE** again. When mute is off, the **MUTE** light turns off.



NOTE: Switching between the handset and speakerphone cancels the mute function.

Options while on calls

Chain dialing

Use this feature to initiate a dialing sequence from the numbers in the directory, caller ID history or speed dial memory while you are on a call.

Chain dialing is useful when you wish to access other numbers (such as bank account numbers or access codes) from the directory, caller ID history or speed dial memory.

To access the directory while on a call:

1. Press **MENU/SELECT**.
2. Press **MENU/SELECT** again to select **Directory**.
3. Press **CALL LOG**▼ or **DIRECTORY**▲ to scroll to the desired number, or press the dialing keys (**0-9**) to start a name search.
4. Press **MENU/SELECT** to dial the displayed number.

To access the caller ID history while on a call:

1. Press **MENU/SELECT**.
2. Press **CALL LOG**▼ or **DIRECTORY**▲ to scroll to **Caller ID log**, then press **MENU/SELECT**.
3. Press **CALL LOG**▼ or **DIRECTORY**▲ to scroll to the desired number.
4. Press **MENU/SELECT** to dial the displayed number.

To access the speed dial memory while on a call:

1. Press **SPEED DIAL**.
2. Press **CALL LOG**▼ or **DIRECTORY**▲ to scroll to the desired number, then press **MENU/SELECT** to dial the displayed number.

-OR-

Press the dialing key (**0-9**) to dial the number in the desired speed dialing location.



NOTES:

- You cannot edit a directory entry while on a call. For more details about the directory, see page 19.
- You cannot copy a caller ID entry into the directory while on a call. For more details about the caller ID history, see page 26.
- Press **CANCEL** to exit the directory or caller ID history when on a call.

Options while on calls

Audio Assist®

The Audio Assist® feature makes voices sound louder and clearer.

To turn the Audio Assist® feature on:

Press **AUDIO ASSIST®** while you are on a call using the handset. The screen shows **Handset volume has increased**.

To turn the Audio Assist® feature off:

Press **AUDIO ASSIST®** again. The screen shows **Handset volume back to normal**. This feature is also turned off automatically after you hang up.

Temporary tone dialing

If you have pulse (rotary) service only, you can switch from pulse to touch-tone dialing temporarily during a call. This is useful if you need to send touch-tone signals to access your telephone banking or long distance services.

1. During a call, press **TONEX**.
2. Use the dialing keys to enter the desired number. The telephone sends touch-tone signals.
3. The telephone returns to pulse dialing after you end the call.

Directory

Directory memory capacity

The directory can store up to 25 telephone numbers and names. Numbers can be up to 24 digits and names can be up to 15 characters.

Character chart

Refer to the following chart and use the dialing keys to enter the letters, digits or symbols. Press the key repeatedly until the desired character shows on the screen.

| Dial Key | Characters by number of key press | | | | | | | | |
|----------|-----------------------------------|---|---|---|---|---|---|---|---|
| | 1 | 2 | 3 | 4 | 5 | 6 | 7 | 8 | 9 |
| 1 | 1 | . | , | - | / | & | | | |
| 2 | A | B | C | 2 | a | b | c | | |
| 3 | D | E | F | 3 | d | e | f | | |
| 4 | G | H | I | 4 | g | h | i | | |
| 5 | J | K | L | 5 | j | k | l | | |
| 6 | M | N | O | 6 | m | n | o | | |
| 7 | P | Q | R | S | 7 | p | q | r | s |
| 8 | T | U | V | 8 | t | u | v | | |
| 9 | W | X | Y | Z | 9 | w | x | y | z |
| 0 | 0 | | | | | | | | |
| * | * | | | | | | | | |
| # | # | | | | | | | | |

Create a new directory entry

1. Press **MENU/SELECT** in idle mode to enter the main menu.
2. Press **CALL LOG** ▼ or **DIRECTORY** ▲ to scroll to **Directory**, then press **MENU/SELECT**.
3. Press **CALL LOG** ▼ or **DIRECTORY** ▲ to highlight **Add contact**.
4. Press **MENU/SELECT**. The screen shows **Enter number**.
5. Use the dialing keys to enter a telephone number (up to 24 digits) when prompted.
 - Press **CALL LOG** ▼ or **DIRECTORY** ▲ to move the cursor to the left or right.
 - Press **DELETE X** to erase a digit.
 - Press **REDIAL/PAUSE** to enter a three-second dialing pause (a **P** appears).

-OR-

Copy the number from the redial memory by pressing **REDIAL/PAUSE**.

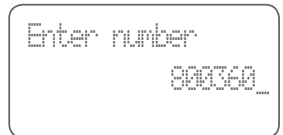
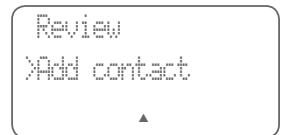

Directory

6. Press **MENU/SELECT**. The screen shows **Enter name**.
7. Use the dialing keys to enter a name (up to 15 characters) when prompted. Each time you press a key, the character on that key appears. Additional key presses produce other characters on that key. See the chart on the previous page.
 - Press **CALL LOG**▼ or **DIRECTORY**▲ to move the cursor to the left or right.
 - Press **DELETE X** to erase a character.
8. Press **MENU/SELECT** to store your new directory entry. There is a confirmation tone and the screen shows **Saved**. To change the entry later, see page 22.

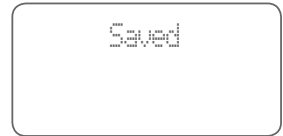

i NOTE: Numbers can be up to 24 digits and names can be up to 15 characters. If you enter more than 24 digits and 15 characters, you will hear an error tone.

Review directory entries

1. Press **DIRECTORY**▲ when in idle mode. The first entry in the directory shows.

-OR-

 Press **MENU/SELECT** when in idle mode, then press **CALL LOG**▼ or **DIRECTORY**▲ to scroll to **Directory**. Press **MENU/SELECT**, then press **CALL LOG**▼ or **DIRECTORY**▲ to scroll to **Review**, press **MENU/SELECT**.
2. Press **CALL LOG**▼ or **DIRECTORY**▲ to browse through the directory. Entries appear alphabetically by the first letter in the name.

i NOTES:

- If the telephone number in the directory exceeds 15 digits, <# appears in front of the telephone number. Press **TONEX** to move towards the end of the telephone number or press # (pound key) to move towards the beginning of the telephone number.
- **Directory empty Add contact?** appears if there are no directory entries.

Directory

Search by name

1. Press **DIRECTORY▲** in idle mode to show the first listing in the directory.
2. When an entry appears, press the dialing keys (**0-9**) to start a name search. The directory shows the first name beginning with the first letter associated with the dialing key, if there is an entry in the directory beginning with that letter. Press **CALL LOG▼** or **DIRECTORY▲** to scroll through the directory.
3. To see other names starting with the letters on the same dialing key, keep pressing the key. The names appear in alphabetical order based on the first letter in the name.

For example, if you have the names **Jennifer**, **Jessie**, **Kevin** and **Linda** in your directory:

- If you press **5 (JKL)** once, you see **Jennifer**. Press **CALL LOG▼** and you see **Jessie**.
- If you press **5 (JKL)** twice, you see **Kevin**.
- If you press **5 (JKL)** three times, you see **Linda**.
- If you press **5 (JKL)** four times, you see **5** and then the directory entry beginning with 5 or the next closest entry after 5.
- If you press **5 (JKL)** five times, you see **Jennifer** again.



NOTE: If there is no name matching the first letter of the key you press, the directory shows a name matching the following letters of the key.

Directory

To dial, delete or edit a directory entry (name and number), the entry must be displayed on the screen. Use **Review directory entries** (page 20) or **Search by name** (page 21) to show an entry.

Display dial

To dial a displayed number from the directory, lift the handset or press  **SPEAKER** on the telephone.

Delete a directory entry

To delete the displayed directory entry, press **DELETE X**. The screen displays **Delete contact?**. Press **MENU/SELECT** or **DELETE X** to confirm. The screen shows **Deleted** with a confirmation tone. You cannot retrieve a deleted entry.

Edit a directory entry

1. When a directory entry displays, press **MENU/SELECT**. The screen shows **Enter number** along with the phone number to be edited. If you only want to edit the name, skip to Step 3.
2. To edit the number:
 - Press the dialing keys to add digits.
 - Press **CALL LOG**▼ or **DIRECTORY**▲ to move the cursor to the left or right.
 - Press **DELETE X** to erase a digit.
 - Press **REDIAL/PAUSE** to add a three-second dialing pause (a **P** appears).
3. Press **MENU/SELECT** to move on to the name. The screen shows **Enter name** along with the name to be edited.
4. To edit the name:
 - Press the dialing keys to add characters (page 19).
 - Press **CALL LOG**▼ or **DIRECTORY**▲ to move the cursor to the left or right.
 - Press **DELETE X** to erase a character.
5. Press **MENU/SELECT** to save the entry. There is a confirmation tone and the screen shows **Saved**.

Speed dial

The telephone system has 10 speed dial locations (**0-9**) where you can store the telephone numbers you wish to dial more quickly. You can store up to 24 digits in each location. A speed dial number can be selected from the directory or caller ID history, or entered directly. Numbers assigned to speed dial locations are stored in the directory.

Enter a speed dial number

1. Press **SPEED DIAL** when the telephone is in idle mode.
2. Press **DIRECTORY▲** or **CALL LOG▼** to choose your desired speed dial location (**0-9**), then press **MENU/SELECT**. The screen shows **Press [SELECT]**.

-OR-

Use the dialing keys (**0-9**) to select your desired speed dial location (**0-9**). The screen shows **Press [SELECT]**.

3. Press **MENU/SELECT**, the screen shows **Enter number**. Use the dialing keys to enter a telephone number (up to 24 digits).



- Press **CALL LOG▼** or **DIRECTORY▲** to move the cursor to the left or right.
- Press **DELETE X** to erase a digit.
- Press **REDIAL/PAUSE** to enter a three-second dialing pause (a **P** appears).

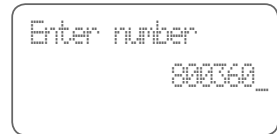

-OR-

Copy the number from the redial memory by pressing **REDIAL/PAUSE**.

4. Press **MENU/SELECT** to move on to the name. The screen shows **Enter name**.
5. Use the dialing keys to enter a name (up to 15 characters) when prompted. Each time you press a key, the character on that key appears. Additional key presses produce other characters on that key. See the chart on page 19.
 - Press **CALL LOG▼** or **DIRECTORY▲** to move the cursor to the left or right.
 - Press **DELETE X** to erase a character.
 - Press **DIRECTORY▲** to add a space between words.
6. Press **MENU/SELECT** to store your new directory entry. The screen shows **Saved** with a confirmation tone.

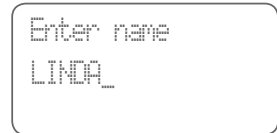

NOTES:

- Numbers can be up to 24 digits and names can be up to 15 characters. If you enter more than 24 digits and 15 characters, you hear an error tone.
- You cannot enter a new number to speed dial location when the directory is full. You have to delete some directory entries (page 22) to make room for new storage.

Speed dial

Assign a speed dial number from the directory or caller ID log

1. When reviewing directory (page 20) or caller ID log (page 29), press **SPEED DIAL**. The screen shows **Assign to speed dial list?**. Press **MENU/SELECT**.



2. Press **DIRECTORY▲** or **CALL LOG▼** to choose your desired speed dial location (**0-9**), then press **MENU/SELECT**.

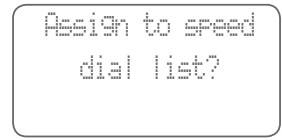

-OR-

Use the dialing keys (**0-9**) to select the desired speed dial location (**0-9**).

3. If the speed dial location is empty, the screen shows **Assigned to speed dial #X** (X refers to the speed dial location).



-OR-

If the speed dial location is occupied, the screen shows **Replace?**. Press **MENU/SELECT** to confirm. The screen shows **Assigned to speed dial #X** (X refers to the speed dial location).



 **NOTE:** You cannot assign a caller ID log entry to speed dial when the directory is full. You have to delete some directory entries (page 22) to make room for new assignments.

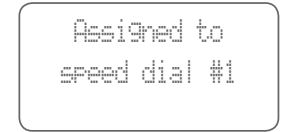

Delete a speed dial number

1. Press **SPEED DIAL** when the telephone is in idle mode.

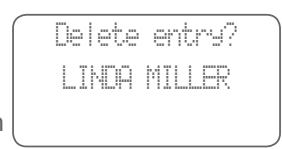

2. Press **DIRECTORY▲** or **CALL LOG▼**, or dialing keys (**0-9**) to select the desired location, then press **DELETE X** to delete the displayed speed dial number. The screen displays **Delete entry?** with the name.

3. Press **MENU/SELECT** to confirm. There is a confirmation tone and the screen shows **Deleted**.

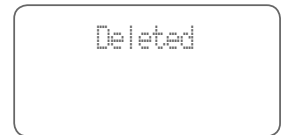

Speed dial

Review a speed dial number

1. Press **SPEED DIAL** when the telephone is in idle mode.
2. Press **CALL LOG** ▼ or **DIRECTORY** ▲ to scroll to the desired location, then press **MENU/SELECT**.

-OR-

Press the dialing key **(0-9)** of the desired location.

Dial a speed dial number

When the telephone is in idle mode, press and hold the dialing keys **(0-9)** to dial the corresponding speed dial number.

-OR-

1. Press **SPEED DIAL** when the telephone is in idle mode.
2. Press **CALL LOG** ▼ or **DIRECTORY** ▲ to scroll to the desired location, then press **MENU/SELECT**.

-OR-

Press the dialing key **(0-9)** of the desired location.

3. Lift the handset or press **📞SPEAKER** to dial.

-OR-

1. Lift the handset or press **📞SPEAKER**.
2. Press **SPEED DIAL**.
3. Press **CALL LOG** ▼ or **DIRECTORY** ▲ to scroll to the desired location, then press **MENU/SELECT**.

-OR-

Press the dialing key **(0-9)** of the desired location.

About caller ID

This product supports caller ID services offered by most telephone service providers. Caller ID allows you to see the name, number, date and time of calls. The available caller ID information will appear after the first or second ring.

Information about caller ID with call waiting

Caller ID with call waiting lets you see the name and telephone number of the caller before answering the call, even while on another call.

It may be necessary to change your telephone service to use this feature. Contact your telephone service provider if:

- You have both caller ID and call waiting, but as separate services (you may need to combine these services).
- You have only caller ID service, or only call waiting service.
- You don't subscribe to caller ID or call waiting services.

There are fees for caller ID services. In addition, services may not be available in all areas.

This product can provide information only if both you and the caller are in areas offering caller ID service and if both telephone service providers use compatible equipment. The time and date, along with the call information, are from the telephone service provider.

Caller ID information may not be available for every incoming call. Callers may intentionally block their names and/or telephone numbers. You can only view and store a maximum of 15 digits or characters of every caller ID log entry.



NOTE: You can use this product with regular caller ID service, or you can use this product's other features without subscribing to caller ID or combined caller ID with call waiting service.

Caller ID history

How the caller ID history (caller ID log) works

The telephone stores caller ID information about the last 50 incoming calls. Entries are stored in reverse chronological order. The phone deletes the oldest entry when the log is full to make room for new calls. If you answer a call before the information appears on the screen, it does not show in the caller ID history.

Missed (new) call indicator

When the telephone is in idle mode and has new or missed calls, its screen shows **XX Missed calls**.

All new and missed entries are counted as missed calls. Each time you review a new caller ID log entry (indicated by the **NEW** icon on the screen), the number of missed calls decreases by one.

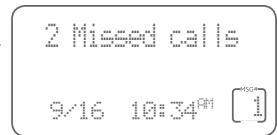

When the telephone is in idle mode, you can press and hold **CANCEL** to temporarily clear the missed call indicator and/or new message indicator. There is a confirmation tone.

Caller ID operation

Memory match

If the incoming telephone number matches the last seven digits of a telephone number in your directory, the name that appears on the screen matches the corresponding name in your directory.

For example, if Christine Smith calls, her name appears as **CHRIS** if this is how you entered it into your directory.

 **NOTE:** The number shown in the caller ID log will be in the format sent by the telephone service provider. The telephone service provider usually delivers 10-digit phone numbers (area code plus telephone number). If the telephone number of the caller does not match a number in your directory, the name will appear as it is delivered by the telephone service provider.



Caller ID operation

Review the caller ID history

Review the caller ID history to find out who called, to return the call, or to copy the caller's name and number into your directory. **Caller ID log empty** appears if there are no records in the caller ID log.



1. When the telephone is in idle mode, press **CALL LOG**▼ to review the caller ID history in reverse chronological order starting with the most recent call.

-OR-

Review the caller ID history by pressing **MENU/SELECT**. Press **CALL LOG**▼ or **DIRECTORY**▲ to scroll to **Caller ID log**, then press **MENU/SELECT**. Press **CALL LOG**▼ or **DIRECTORY**▲ to scroll to **Review**, and then press **MENU/SELECT**.

2. Press **CALL LOG**▼ or **DIRECTORY**▲ to scroll through the list.
3. Press **CANCEL** to exit the caller ID history.

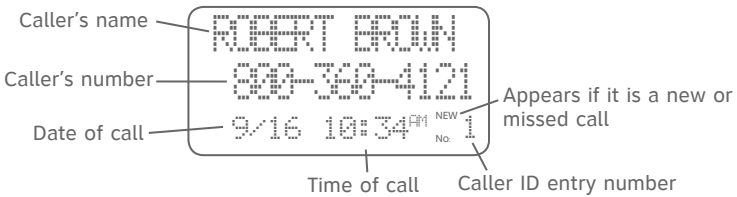

Caller ID operation

View dialing options

Although the incoming caller ID log entries have 10 digits (the area code plus the seven-digit number), in some areas, you may need to dial only the seven digits, 1 plus the seven digits, or 1 plus the area code plus the seven digits. You can change and store the number of digits that you dial in the caller ID log.

While reviewing the caller ID log, press # (pound key) repeatedly to show different dialing options for local and long distance numbers before dialing or saving the telephone number in the directory or speed dial location.

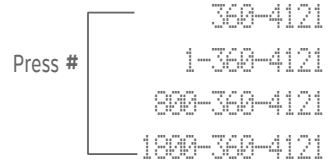

When the number is in the correct format for dialing, lift the handset or press **▶SPEAKER** to call the number.

To save the number to the directory or speed dial location, see **Save a caller ID log entry to the directory** on the next page or see **Assign a speed dial number from the directory or caller ID log** on page 24.

Dial a caller ID log entry

1. When in the caller ID log, press **CALL LOG▼** or **DIRECTORY▲** to browse.
2. Lift the handset or press **▶SPEAKER** to dial the displayed entry.

Delete caller ID log entries

To delete an entry:

Press **DELETE X** to delete the shown entry. There is a confirmation tone and the screen shows **Deleted**.



To delete all entries:

1. Press **MENU/SELECT** when in idle mode.
2. Press **CALL LOG▼** or **DIRECTORY▲** to scroll to **Caller ID log**, then press **MENU/SELECT**.
3. Press **CALL LOG▼** or **DIRECTORY▲** to scroll to **Del all calls**, then press **MENU/SELECT**.
4. When the screen shows **Delete all calls?**, press **MENU/SELECT** to confirm. There is a confirmation tone and the screen shows **All calls deleted**.

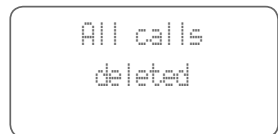
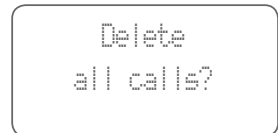

Caller ID operation

Save a caller ID log entry to the directory

1. When in the caller ID log, press **CALL LOG** ▼ or **DIRECTORY** ▲ to browse.
2. Press **MENU/SELECT** to select an entry.
3. When the screen displays **Enter number**, use the dialing keys to edit the number.
 - Press **CALL LOG** ▼ or **DIRECTORY** ▲ to move the cursor to the left or right.
 - Press **DELETE X** to erase a digit.
 - Press **REDIAL/PAUSE** to insert a three-second dialing pause (a **P** appears).
4. Press **MENU/SELECT**.
5. When the screen displays **Enter name**, use the dialing keys (page 19) to edit the name.
 - Press **CALL LOG** ▼ or **DIRECTORY** ▲ to move the cursor to the left or right.
 - Press **DELETE X** to erase a character.
6. Press **MENU/SELECT**. The screen shows **Saved to directory** with a confirmation tone.

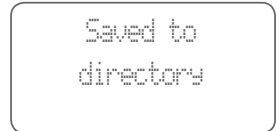

i **NOTE:** You may need to change how a caller ID number is dialed if the entry does not appear in the correct format. Caller ID numbers may appear with an area code that is not necessary for local calls, or without a 1 that is necessary for long distance calls (see **View dialing options** on page 30).

Caller ID operation

Set area code

You can set one home area code and four local area codes. If you dial seven digits to make a local call (no area code required), enter your area code into the telephone as the home area code. When you receive a call from within your home area code, the caller ID history only displays the seven digits of the telephone number.

If you dial 10 digits to make calls to areas outside your home area code, then set local area codes into the telephone. After setting, if you receive a call from one of these local area codes, the screen displays the 10 digits of the telephone number.

To set the area codes:

1. Press **MENU/SELECT** in idle mode to enter the main menu.
2. Press **CALL LOG**▼ or **DIRECTORY**▲ to scroll to **Caller ID log**, then press **MENU/SELECT**.
3. Press **CALL LOG**▼ or **DIRECTORY**▲ to scroll to **Set area code**, then press **MENU/SELECT**.
4. Press **CALL LOG**▼ or **DIRECTORY**▲ to scroll to **Home area code** or **Local area (1 - 4)**, then press **MENU/SELECT**.
5. Use the dialing keys to enter a three-digit area code. Press **DELETE X** to clear the three-digit area code.
6. Press **MENU/SELECT** to save.

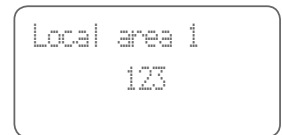

Reasons for missing caller ID information

There are occasions when other information or no information shows for various reasons:

| On-screen message | Reason |
|-------------------|--------------------------------------------------------------------------------------------------------------------------------------------------------|
| PRIVATE NUMBER | The caller prefers not to show the phone number. |
| PRIVATE NAME | The caller prefers not to show the name. |
| PRIVATE CALLER | The caller prefers not to show the phone number and name. |
| UNKNOWN NUMBER | Your telephone service provider cannot determine the caller's number. |
| UNKNOWN NAME | Your telephone service provider cannot determine the caller's name. |
| UNKNOWN CALLER | Your telephone service provider cannot determine the caller's name and telephone number. Calls from other countries may also generate this message. |

Answering system settings

Use the answering system menu of the telephone to set up the announcement message, message alert, activate call screening, or change the number of rings, remote access code or priority code.

1. When the telephone is in idle mode, press **MENU/SELECT** to enter the main menu.
2. Press **MENU/SELECT** again to select **Answering sys.**



Announcement

Your outgoing announcement plays when calls are answered by the answering system.

The telephone has a default outgoing announcement, "Hello. Please leave a message after the tone." You can use this announcement, or record your own.

You can record an announcement of up to three minutes. The system does not record any announcement shorter than two seconds.

To play your current outgoing announcement:

1. When the telephone is in idle mode, press **MENU/SELECT** to enter the main menu.
2. Press **MENU/SELECT** again to select **Answering sys.**
3. Press **CALL LOG**▼ or **DIRECTORY**▲ to scroll to **Announcement**, then press **MENU/SELECT**.
4. Press **CALL LOG**▼ or **DIRECTORY**▲ to scroll to **Play current**, then press **MENU/SELECT**.

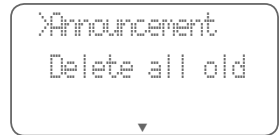

To record a new outgoing announcement:

1. When the telephone is in idle mode, press **MENU/SELECT** to enter the main menu.
2. Press **MENU/SELECT** again to select **Answering sys.**
3. Press **CALL LOG**▼ or **DIRECTORY**▲ to scroll to **Announcement**, then press **MENU/SELECT**.
4. Press **CALL LOG**▼ or **DIRECTORY**▲ to scroll to **Record new**, then press **MENU/SELECT**. The system announces, "Record after the tone. Press 5 when you are done."
5. Speak towards the telephone to record your announcement. Press **5** to end recording. Your recorded announcement plays.

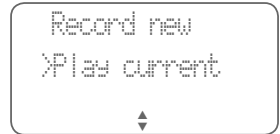

To listen to the recorded announcement again, scroll to **Play current** and press **MENU/SELECT**.

Answering system settings

To delete your outgoing announcement:

1. When the telephone is in idle mode, press **MENU/SELECT** to enter the main menu.
2. Press **MENU/SELECT** again to select **Answering sys.**
3. Press **CALL LOG** ▼ or **DIRECTORY** ▲ to scroll to **Announcement**, then press **MENU/SELECT**.
4. Press **CALL LOG** ▼ or **DIRECTORY** ▲ to scroll to **Play current**, then press **MENU/SELECT**.
5. While the announcement is playing, press **DELETE X** to delete the announcement. The screen shows **Deleted** and the system announces, "Deleted" followed by "Hello, please leave a message after the tone."

When your announcement is deleted, the system answers calls with the default announcement described on the previous page. You cannot delete the default announcement.

To reset your outgoing announcement:

1. Follow steps 1-3 in **To delete your outgoing announcement** section.
2. Press **CALL LOG** ▼ or **DIRECTORY** ▲ to scroll to **Reset annnc**, then press **MENU/SELECT**. The screen shows **Reset annnc to default?**.
3. Press **MENU/SELECT** to confirm. There is a confirmation tone. The screen shows **Announcement Reset**.

When your announcement is reset, the system answers calls with the default announcement described on the previous page.

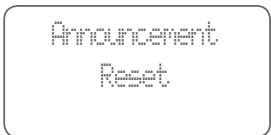
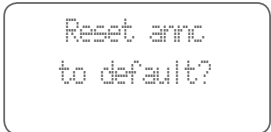
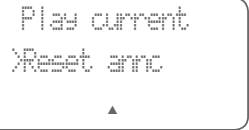

To turn on or off the answering system

To turn the answering system on or off:

Press **ANS ON** Ⓞ to turn the answering system on or off. When the answering system is turned on, it announces, "Calls will be answered" and the **ANS ON** Ⓞ light is on. When the answering system is turned off, it announces, "Calls will not be answered" and the **ANS ON** Ⓞ light is off.

Answering system settings

Number of rings

You can set the answering system to answer an incoming call after two, three, four, five, six or seven rings. You can also select toll saver 2-4 or toll saver 4-6. If toll saver 2-4 is selected, the answering system answers a call after two rings when you have new messages, or after four rings when there are no new messages. If toll saver 4-6 is selected, the answering system answers a call after four rings when you have new messages, and after six rings when there are no new messages. The toll saver feature allows you to check for new messages and avoid paying long distance charges when calling from out of your local area. By default, the answering system answers an incoming call after 4 rings.

To set the number of rings:

1. When the telephone base is in idle mode, press **MENU/SELECT** to enter the main menu.
2. Press **MENU/SELECT** again to select **Answering sys.**
3. Press **CALL LOG** ▼ or **DIRECTORY** ▲ to scroll to **# of rings**, then press **MENU/SELECT**.
4. Press **CALL LOG** ▼ or **DIRECTORY** ▲ to choose **2, 3, 4, 5, 6, 7, Toll saver 2-4** or **Toll saver 4-6**.
5. Press **MENU/SELECT** to save the setting. You hear a confirmation tone and the screen returns to the previous menu.

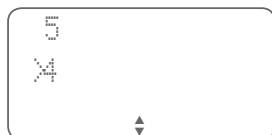
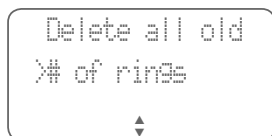



Call screening

Use this feature to choose whether incoming messages can be heard over the speaker when they are being recorded. If you turn call screening on, you hear the incoming message. While monitoring an incoming message, you can answer the call by lifting the handset or pressing **▶** **SPEAKER**. By default, the call screening is set to **On**.

To change the setting:

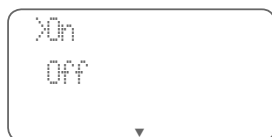
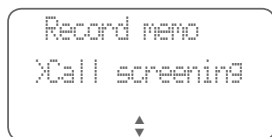
1. When the telephone is in idle mode, press **MENU/SELECT** to enter the main menu.
2. Press **MENU/SELECT** again to select **Answering sys.**
3. Press **CALL LOG** ▼ or **DIRECTORY** ▲ to scroll to **Call screening**, then press **MENU/SELECT**.
4. Press **CALL LOG** ▼ or **DIRECTORY** ▲ to choose **On** or **Off**.
5. Press **MENU/SELECT** to save the setting. The screen returns to the previous menu.



 **NOTE:** For more information on call screening, see page 39.

Answering system settings

Message alert

If the message alert is set to **On**, you can hear the telephone beeps every 15 seconds when there are new messages.

To change the setting:

1. When the telephone is in idle mode, press **MENU/SELECT** to enter the main menu.
2. Press **MENU/SELECT** again to select **Answering sys.**
3. Press **CALL LOG**▼ or **DIRECTORY**▲ to scroll to **Message alert**, then press **MENU/SELECT**.
4. Press **CALL LOG**▼ or **DIRECTORY**▲ to choose **On** or **Off**.
5. Press **MENU/SELECT** to save the setting. There is a confirmation tone and the screen returns to the previous menu.

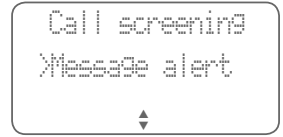

Remote code

To access your answering system remotely from any touch-tone phone, you need to enter a three-digit number. The default remote access code is **500**.

To change the remote code:

1. When the telephone base is in idle mode, press **MENU/SELECT** to enter the main menu.
2. Press **MENU/SELECT** again to select **Answering sys.**
3. Press **CALL LOG**▼ or **DIRECTORY**▲ to scroll to **Remote code**, then press **MENU/SELECT**.
4. Use the dialing keys to enter a three-digit number.
5. Press **MENU/SELECT** to save the setting. You hear a confirmation tone and the screen returns to the previous menu.

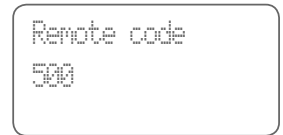

Answering system settings

Priority code

You may give the priority code to whom you would like them to have higher priority when calling you. When the priority code is entered while the answering system is playing the outgoing announcement, the answering system announces, *"Please wait a moment"* to the caller. The telephone then plays the priority call tone for 30 seconds to alert you that it is a priority call. The default priority code is **999**.

To change the setting:

1. When the telephone is in idle mode, press **MENU/SELECT** to enter the main menu.
2. Press **MENU/SELECT** again to select **Answering sys.**
3. Press **CALL LOG** ▼ or **DIRECTORY** ▲ to scroll to **Priority code**, then press **MENU/SELECT**.
4. Use the dialing keys to enter a three-digit number.
5. Press **MENU/SELECT** to save the setting. You hear a confirmation tone and the screen returns to the previous menu.

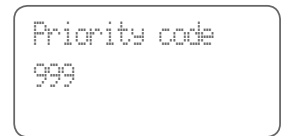

About the answering system

Message capacity

The system can record up to 99 messages. Individual messages can be up to three minutes. The total recording time for the announcement, messages and memos is approximately 25 minutes. If the memory is full, the answering system announces, "Memory is full" before message playback. The screen displays **Memory is full** in idle mode. Once the memory is full, the answering system will not answer calls even it is turned on, nor can you record new messages until old ones have been deleted.

Messages remain available for replay until you delete them. When there are new messages (including memos) on the answering system, the screen shows **XX new messages**.

When the telephone is in idle mode, you can press and hold **CANCEL** to temporarily clear the missed call indicator and/or new message indicator. There is a confirmation tone.

Voice prompts

The system provides voice prompts to guide you through the setup procedures, message playback, remote access and recording outgoing announcements.

Call screening

If the answering system and call screening are on (see **Call screening** on page 36), the announcement and the incoming message are broadcast at the telephone when a call is answered by the answering system.

Options while a message is being recorded:

- Press **▲VOLUME▼** to adjust the call screening volume.
- Press **🔊 SPEAKER** or lift the handset to answer the call.

Call intercept

While screening a call, you can stop recording and speak to the caller by pressing **🔊 SPEAKER** or lifting the handset.

Message Guard®

The answering system protects the recorded messages from being lost in the event of a power failure.

Message playback

If you have new messages, you hear only the new messages in chronological order. If there are no new messages, the system plays back all the messages in chronological order.

Before each message, you hear the day and time of the recording. If the date and time are not set, you hear, *"Time and date not set"* before playback. The system announces, *"End of messages"* after all messages are played back.

To listen to messages:

Press **PLAY/STOP▶/■** to listen to the messages.

The system announces the day and time of messages, then begins playback. The message sequence is shown on the telephone. If there are no recorded messages, the telephone base shows **Playing message** and you hear, *"You have no messages."*

Options during playback

When a message is playing, you can adjust the playback volume, skip, repeat, stop or delete the message.

When messages are playing on the telephone:

- Press **▲VOLUME▼** to adjust the message playback volume.
- Press **SKIP ▶▶** to skip to the next message.
- Press **◀◀ REPEAT** to repeat the message. Press twice to hear the previous message.
- Press **DELETE X** to delete the message.
- Press **PLAY/STOP▶/■** to stop the playback.
- Press **MENU/SELECT** to stop playback. The screen shows **Call back?**, then press **MENU/SELECT** to call back the caller if the caller's number is available. Or press **CANCEL** to resume playing message from beginning.

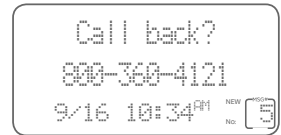

Delete all old messages

1. When the telephone is in idle mode, press **MENU/SELECT** to enter the main menu.
2. Press **MENU/SELECT** again to select **Answering sys.**
3. Press **CALL LOG▼** or **DIRECTORY▲** to scroll to **Delete all old**, then press **MENU/SELECT**. The screen shows **Delete all old messages?**
4. Press **MENU/SELECT** to confirm. The telephone announces, *"All old messages deleted"* with a confirmation tone.

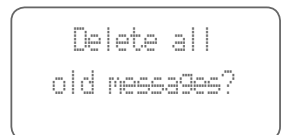
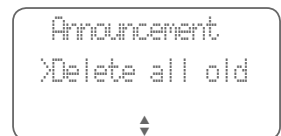

Message playback

-OR-

1. When the telephone is in idle mode, press **DELETE X**. The system announces, *"To delete all old messages, press delete again."*
2. Press **DELETE X** again to confirm. The system announces, *"All old messages deleted."* with a confirmation tone.



NOTE: When there are no old messages and you press **DELETE X**, the system announces, *"You have no old messages."*

Memo

Memos are messages you record as reminders for yourself or others using the same answering system. Play and delete memos the same way as incoming messages (see **Options during playback** on the previous page).

To record a memo:

1. When the telephone is in idle mode, press **MENU/SELECT** to enter the main menu.
2. Press **MENU/SELECT** again to select **Answering sys.**
3. Press **CALL LOG ▼** or **DIRECTORY ▲** to scroll to **Record memo**, then press **MENU/SELECT**.
4. The screen shows **Recording memo... Press 5 to stop** and the system announces, *"Record after the tone. Press 5 when you are done."*
5. Press **5** to end recording. The screen shows **Memo recorded** with a confirmation tone.

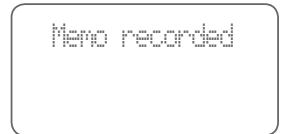
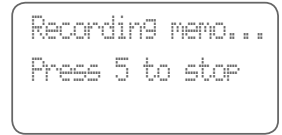



-OR-

Press **◀ REPEAT** in idle mode, then follow steps 4-5 to record a memo.

Message counter displays

The base message counter shows the total number of answering system messages. See the following table for other message counter displays.

Message counter displays

| | |
|-----------------------------------------------------------------------------------|-------------------------------------|
|  | No messages. |
|  | Total number of messages and memos. |

Remote access

You can reach your answering system remotely by dialing your home telephone number from any touch-tone telephone.

To remotely reach your answering system:

1. Dial your telephone number from any touch-tone telephone.
2. When the system answers, enter the three-digit remote access code (**500** is the default code. See page 37 to change it).
3. You can also enter the following remote commands:

Remote commands

| | |
|-----------|-------------------------------------------------------------------------------------------------------------------------------------------------------------------------------------------------------------|
| 1 | Press to listen to all messages. |
| 2 | Press to listen to new messages only. |
| 3 | Press to delete the current message (during playback). |
| ∗3 | Press to delete all old messages. |
| 4 | Press to repeat the current message (during message playback). Press to play the previous message (during day and time playback). Press twice to play the previous message (during message playback). |
| 5 | Press to stop message playback. |
| 6 | Press to skip to the next message (during playback). |
| 7 | Press to play the announcement. |
| 8 | Press to record a new announcement. |
| 0 | Press to turn the answering system on or off. |

4. Hang up to end the call.





NOTES:

- If the answering system is set to on, the call will be answered. If the answering system is set to off, the answering system answers after 10 rings and announces, "Enter remote access code." If the memory is full, the answering system answers after 10 rings and announces, "Memory is full. Enter remote access code."
- During remote access, if you pause for more than five seconds, you hear a help menu listing all features and commands.
- Cut out and carry the remote access wallet card at the back of this user's manual for quick reference.

Screen icons and alert tones

Screen icons

| | |
|-----------------------------------------------------------------------------------|----------------------------------------------------|
|  | Ringer off - the telephone ringer is off. |
| NEW | New caller ID log - new and missed calls. |
|  | Message counter - total number of messages. |

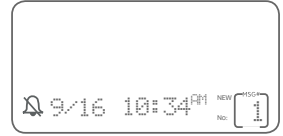

Alert tones

| | |
|-----------------------------------------------|----------------------------------------------------------------------------------------------------------------------------------------------------------------------------------------|
| One short beep | Tone of each key press. |
| One long beep | The system begins recording a message, memo or announcement. |
| Two short beeps | You are pressing ▲VOLUME▼ on the telephone base when the volume is already at its highest or lowest setting. -OR- Call waiting tone. -OR- Error tone. |
| Confirmation tone (three rising tones) | The system has completed the command successfully. |
| Beeps every 15 seconds | Message alert. |

Lights

Indicator lights

IN USE

On when the answering system is answering an incoming call.

Flashes quickly when there is an incoming call.

PLAY/STOP 

On when the system is playing messages.

Flashes when there are new messages.

ANS ON 

On when the answering system is on.

 **SPEAKER**

On when the speakerphone is on.

MUTE

On when the microphone is muted.



Display screen messages

Screen messages

| | |
|---------------------------------|------------------------------------------------------------------------------------------------------------------------|
| Assigned to speed dial #X | A number is assigned to the speed dial location. |
| All calls deleted | All the entries stored in the call history have been deleted. |
| Announcement reset | The announcement has been reset. |
| Caller ID log empty | There are no caller ID history entries. |
| Deleted | A directory entry, caller ID log entry or speed dial number is deleted. Outgoing announcement is reset and deleted. |
| Directory empty Add contact? | There are no directory entries. |
| Directory is full | The directory is full. You cannot save any new entries unless you delete some current entries. |
| Incoming call | There is an incoming call. |
| Line in use | The telephone is recording a message. Another telephone is in use on the same line. |
| Memo recorded | A memo has been recorded. |
| No AC POWER | There is no AC POWER. Check the power adapter connection to the telephone and the electrical wall outlet. |
| No line | There is no telephone line connection. |
| Redial empty | There are no entries in the redial memory. |
| Saved | An entry is saved to the directory or speed dial memory. |
| Saved to directory | A number is saved to the directory. |
| XX Missed calls | There are new calls in the caller ID history. |
| XX new messages | There are new messages in the answering system. |

Troubleshooting

If you have difficulty with your telephone, please try the following suggestions. For Customer Service, visit our website at www.telephones.att.com or call **1 (800) 222-3111**. In Canada, dial **1 (866) 288-4268**.

My telephone doesn't work at all.

- Make sure the power cord is securely plugged in.
- Make sure you plug the telephone line cord securely and firmly into the telephone and the telephone wall jack.
- Reset the telephone. Unplug the electrical power. Wait for approximately 15 seconds, then plug it back in. Allow up to one minute for the telephone to reset.

The display shows No line. I cannot get a dial tone.

- Try all the suggestions, as mentioned above.
- If the previous suggestions do not work, disconnect the telephone line cord from your telephone and connect the telephone line cord to another telephone.
 - If there is no dial tone on that other telephone either, your telephone line cord may be defective. Install a new telephone line cord.
 - If changing the telephone line cord does not help, the wall jack (or the wiring to this wall jack) may be defective. Try using a different wall jack in your home to connect your CL4940 telephone, or contact your telephone service provider (charges may apply).

I cannot dial out.

- Try all the suggestions, as mentioned above.
- Make sure you have a dial tone before dialing.
- Eliminate any background noise. Noise from a television, radio or other appliance may cause the phone to not dial out properly. If you cannot eliminate the background noise, first try muting the telephone before dialing, or dialing from another room with less background noise.
- If other phones in your home are having the same problem, contact your telephone service provider (charges may apply).

I hear other calls while using my phone.

- Disconnect the telephone from the telephone jack, and plug in a different telephone. If you still hear other calls, call your telephone service provider.

System announces, "Time and day not set."

- You need to set the system clock (page 10).

Troubleshooting

I get noise or static when I use the telephone base.

- If you subscribe to high-speed Internet service (DSL - digital subscriber line) through your telephone line, you must install a DSL filter between the telephone line cord and the telephone wall jack (page 4). The filter prevents noise and caller ID problems as a result of DSL interference. Please contact your DSL service provider for more information about DSL filters.
- Do not install this phone near a microwave oven or on the same electrical outlet. You may experience decreased performance while the microwave oven is operating.
- If you plug your phone in with a modem or a surge protector, plug the phone (or modem/surge protector) into a different location. If this does not solve the problem, relocate your phone or modem farther apart from one another, or use a different surge protector.
- If other phones in your home are having the same problem, contact your telephone service provider (charges may apply).

My caller ID isn't working.

- Caller ID is a subscription service. You must subscribe to this service from your telephone service provider for this feature to work on your phone.
- The call may not be calling from an area that supports caller ID.
- Both your and your caller's telephone service providers must use caller ID compatible equipment.
- If you subscribe to high-speed Internet service (DSL - digital subscriber line) through your telephone line, you must install a DSL filter between the telephone line cord and the telephone wall jack (page 4). The filter prevents noise and caller ID problems resulting from DSL interference. Please contact your DSL service provider for more information about DSL filters.

System does not receive caller ID when on a call.

- Make sure you subscribe to caller ID with call waiting features from your telephone service provider. Caller ID features works only if both you and the caller are in areas offering caller ID service, and if both telephone service providers use compatible equipment.

Incomplete messages.

- If a caller leaves a very long message, part of it may be lost when the system disconnects the call after the recordings exceed the maximum recording time (page 39).
- If the caller pauses for longer than three seconds, the system stops recording and disconnects the call.

Troubleshooting

- If the system's memory becomes full during a message, the system stops recording and disconnects the call.
- If the caller's voice is very soft, the system may stop recording and disconnect the call.

Difficulty hearing messages.

- Press **▲VOLUME** or **▣/EQUALIZER** to increase the telephone speaker volume.

System does not answer after the correct number of rings.

- Make sure that the answering system is on. **ANS ON** **⓪** light on the telephone should be on.
- If toll saver is activated, the number of rings changes to two or four when you have new messages stored (page 36).
- If the memory is full or the system is off, the system will answer after 10 rings.
- In some cases, the answering system is affected by the ringing system used by your telephone service provider.
- If there is a fax machine connected to the same telephone line, try disconnecting the fax machine. If that solves the problem, consult your fax machine documentation for information on compatibility with answering systems.

System does not respond to remote commands.

- Make sure to enter your remote access code correctly (page 37).
- Make sure you are calling from a touch-tone phone. When you dial a number, you should hear tones. If you hear clicks, the phone is not a touch-tone telephone and cannot activate the answering system.
- The answering system may not detect the remote access code while your announcement is playing. Try waiting until the announcement is over before entering the code.
- There may be interference on the phone line you are using. Press dialing keys firmly.

System does not record messages.

- Make sure the answering system is on. **ANS ON** **⓪** light on the telephone should be on.
- Make sure the memory of the answering system is not full.
- If there is a fax machine connected to the same telephone line, try disconnecting the fax machine. If that solves the problem, consult your fax machine documentation for information on compatibility with answering systems.

Troubleshooting

Outgoing announcement is not clear.

- When you record your announcement, make sure you speak in a normal tone of voice, about nine inches from the telephone.
- Make sure there is no background noise (TV, music, etc.) while recording.

I subscribe to a nontraditional telephone service that uses my computer to establish connections, and my telephone doesn't work.

- Make sure your computer is powered on.
- Make sure your Internet connection is working properly.
- Make sure that the software is installed and running for your nontraditional telephone service.
- Make sure to plug your USB telephone adapter into a dedicated USB port on your computer. Do not plug it into a multiple port USB hub (USB splitter) that is not powered.
- In a few rare instances, the USB port on your computer may not have enough power. Try using a USB hub with its own external power supply.
- If you are using a firewall, it may prevent access to your nontraditional telephone service provider. Contact your service provider for more information.

I've set my LCD language to Spanish or French and I don't know how to change it back to English.

Do the following in the order listed to reset the LCD language back to English:

1. Press **CANCEL** repeatedly to ensure that the telephone is in idle mode.
2. Press **MENU/SELECT** once.
3. Press **CALL LOG**▼ five times, then press **MENU/SELECT**.
4. Press **CALL LOG**▼ or **DIRECTORY**▲ to highlight **English**.
5. Press **MENU/SELECT** twice. You hear a confirmation tone.

Common cure for electronic equipment.

If the telephone does not seem to be responding normally, do the following (in the order listed):

1. Disconnect the power to the telephone.
2. Wait a few minutes.
3. Connect power to the telephone.
4. Wait for the telephone to reestablish its connection. Allow up to one minute for this to take place.

Maintenance

Taking care of your telephone

- Your corded telephone contains sophisticated electronic parts, so you must treat it with care.
- Avoid rough treatment.
- Place the handset down gently.
- Save the original packing materials to protect your telephone if you ever need to ship it.

Avoid water

- The telephone can be damaged if it gets wet. Do not use the handset in the rain, or handle it with wet hands. Do not install the telephone base near a sink, bathtub or shower.

Electrical storms

- Electrical storms can sometimes cause power surges harmful to electronic equipment. For your own safety, take caution when using electric appliances during storms.

Cleaning your telephone

- Your telephone has a durable plastic casing that should retain its luster for many years. Clean it only with a soft cloth slightly dampened with water or mild soap.
- Do not use excess water or cleaning solvents of any kind.

Remember that electrical appliances can cause serious injury if used when you are wet or standing in water. If the telephone base should fall into water, DO NOT RETRIEVE IT UNTIL YOU UNPLUG THE POWER CORD AND TELEPHONE LINE CORDS FROM THE WALL. Pull the unit out by the unplugged cords.

Important safety information

 This symbol is to alert you to important operating or servicing instructions that may appear in this user's manual. Always follow basic safety precautions when using this product to reduce the risk of injury, fire, or electric shock.

Safety information

- **Read and understand all instructions in the user's manual. Observe all markings on the product.**
- **Avoid using a telephone during a thunderstorm.** There might be a slight chance of electric shock from lightning.
- **Do not use a telephone in the vicinity of a gas leak.** Under certain circumstances, a spark may be created when the adapter is plugged into the power outlet, or when the handset is replaced in its cradle. This is a common event associated with the closing of any electrical circuit. The user should not plug the phone into a power outlet, and should not put a charged handset into the cradle, if the phone is located in an environment containing concentrations of flammable or flame-supporting gases, unless there is adequate ventilation. A spark in such an environment could create a fire or explosion. Such environments might include: medical use of oxygen without adequate ventilation; industrial gases (cleaning solvents; gasoline vapors; etc.); a leak of natural gas; etc.
- **Do not use this product near water, or when you are wet.** For example, do not use it in a wet basement or shower, or next to a swimming pool, bathtub, kitchen sink, or laundry tub. Do not use liquids or aerosol sprays for cleaning. If the product comes in contact with any liquids, unplug any line or power cord immediately. Do not plug the product back in until it has dried thoroughly.
- **Install this product in a protected location** where no one can trip over any line or power cords. Protect cords from damage or abrasion.
- **If this product does not operate normally, read Troubleshooting in this user's manual on pages 47-50.** If you cannot solve the problem, or if the product is damaged, refer to **Limited warranty** on pages 56-57. Do not open this product except as may be directed in your user's manual. Opening the product or reassembling it incorrectly may expose you to hazardous voltages or other risks.
- **If this product has a three-prong (grounding) plug or a polarized plug with one wide prong, it might not fit in outlets that are not polarized.** Do not defeat the purpose of these plugs. If they do not fit in your outlet, the outlet should be replaced by an electrician.

 **CAUTION:** Use only the power adapter provided with this product. To obtain a replacement, visit our website at www.telephones.att.com or call **1 (800) 222-3111**. In Canada, dial **1 (866) 288-4268**.

Especially about corded telephones

- **Electrical power:** The telephone base must be connected to a working electrical outlet. The electrical outlet should not be controlled by a wall switch. **Calls cannot be made from the handset if the telephone base is unplugged, switched off, or if the electrical power is interrupted.**
- **Power adapter:** The power adapter is intended to be correctly oriented in a vertical or floor mount position. The prongs are not designed to hold the plug in place if it is plugged into a ceiling, under-the-table or cabinet outlet.

SAVE THESE INSTRUCTIONS

FCC and ACTA information

If this equipment was approved for connection to the telephone network prior to July 23, 2001, it complies with Part 68 of the Federal Communications Commission (FCC) rules. If the equipment was approved after that date, it complies with the Part 68 rules and with the Technical Requirements for Connection of Equipment to the Telephone Network adopted by the Administrative Council for Terminal Attachments (ACTA). We are required to provide you with the following information.

1. Product identifier and REN information

The label on the back or bottom of this equipment contains, among other things, an identifier indicating product approval and the Ringer Equivalence Number (REN). This information must be provided to your telephone service provider upon request. For equipment approved prior to July 23, 2001, the product identifier is preceded by the phrase "FCC Reg No." and the REN is listed separately. For equipment approved after that date, the product identifier is preceded by "US" and a colon (:), and the REN is encoded in the product identifier without a decimal point as the sixth and seventh characters following the colon. For example, the product identifier US:AAAEQ03T123XYZ indicates the REN would be 0.3.

The REN is used to determine how many devices you can connect to your telephone line and still have them ring when you are called. In most, but not all areas, the sum of all RENS should be five (5.0) or less. You might want to contact your telephone service provider for more information.

2. Connection and use with the nationwide telephone network

The plug and jack used to connect this equipment to the premises wiring and the telephone network must comply with the applicable Part 68 rules and technical requirements adopted by ACTA. A compliant telephone cord and modular plug is provided with this product. It is designed to be connected to a compatible modular wall jack that is also compliant. An RJ11 jack should normally be used for connecting to a single line and an RJ14 jack for two lines, see installation instructions in the user's manual. This equipment may not be used with coin telephone lines or with party lines. If you have specially wired alarm dialing equipment connected to your telephone line, ensure the connection of this equipment does not disable your alarm equipment. If you have questions about what will disable the alarm equipment, consult your telephone service provider or qualified installer.

3. Repair instructions

If this equipment is malfunctioning, it must be unplugged from the modular wall jack until the problem has been corrected. Repairs to this telephone equipment can only be made by the manufacturer or its authorized agents. For repair procedures, follow the instructions outlined under the limited warranty.

4. Rights of the telephone service provider

If this equipment is causing harm to the telephone network, the telephone service provider may temporarily discontinue your telephone service. The telephone service provider is required to notify you before interrupting service. If advance notice is not practical, you will be notified as soon as possible. You will be given the opportunity to correct the problem and the telephone service provider is required to inform you of your right to file a complaint with the FCC. Your telephone service provider may make changes in its facilities, equipment, operation, or procedures that could affect the proper functioning of this product. The telephone service provider is required to notify you if such changes are planned.

5. Hearing aid compatibility

If this product is equipped with a corded or cordless handset, it is hearing aid compatible.

FCC and ACTA information

6. Programming/testing of emergency numbers

If this product has memory dialing locations, you may choose to store police, fire department and emergency medical service telephone numbers in these locations. If you do, please keep three things in mind:

- a. We recommend that you also write the telephone number on the directory card (if applicable), so that you can still dial the emergency number manually if the memory dialing feature doesn't work.
- b. This feature is provided only as a convenience, and the manufacturer assumes no responsibility for customer reliance upon the memory feature.
- c. Testing the emergency telephone numbers you have stored is not recommended. However, if you do make a call to an emergency number:
 - You must remain on the line and briefly explain the reason for the call before hanging up.
 - Programming/testing of emergency numbers should be performed during off-peak hours, such as in the early morning or late evening, when the emergency services tend to be less busy.

Part 15 of FCC rules

Some telephone equipment generates, uses, and can radiate radio-frequency energy and, if not installed and used properly, may cause interference to radio and television reception. This product has been tested and found to meet the standards for a class B digital device, as specified in Part 15 of the FCC rules.

These specifications are designed to provide reasonable protection against such interference in a residential installation. However, there is no guarantee that interference will not occur in a particular installation.

If this product causes interference to radio, VCR or television reception when it is in use, you might correct the interference with any one or all of these measures:

- Where it can be done safely, reorient the receiving radio, VCR or television antenna.
- To the extent possible, relocate the radio, VCR, television or other receiver with respect to the telephone equipment.
- If this telephone product runs on AC power, plug your product into an AC outlet that's not on the same circuit as one used by your radio, VCR or television.
- Consult a dealer or an experienced radio/TV technician for help.

Modifications to this product, not expressly approved by the manufacturer, could void the user's authority to operate the equipment.

Limited warranty

The AT&T brand is used under license - any repair, replacement or warranty service, and all questions about this product should be directed to: In the United States of America, visit **www.telephones.att.com** or call **1 (800) 222-3111**. In Canada, call **1 (866) 288-4268**.

1. What does this limited warranty cover?

The manufacturer of this AT&T branded product warrants to the holder of a valid proof of purchase ("CONSUMER" or "you") that the product and all accessories provided in the sales package ("PRODUCT") are free from defects in material and workmanship, pursuant to the following terms and conditions, when installed and used normally and in accordance with the PRODUCT operating instructions. This limited warranty extends only to the CONSUMER for products purchased and used in the United States of America and Canada.

2. What will be done if the PRODUCT is not free from defects in materials and workmanship during the limited warranty period ("materially defective PRODUCT")?

During the limited warranty period, the manufacturer's authorized service representative repairs or replaces at the manufacturer's option, without charge, a materially defective PRODUCT. If the manufacturer repairs the PRODUCT, they may use new or refurbished replacement parts. If the manufacturer chooses to replace the PRODUCT, they may replace it with a new or refurbished PRODUCT of the same or similar design. The manufacturer retains the defective parts, modules, or equipment. Repair or replacement of the PRODUCT, at the manufacturer's option, is your exclusive remedy. The manufacturer returns the repaired or replacement products to you in working condition. You should expect the repair or replacement to take approximately 30 days.

3. How long is the limited warranty period?

The limited warranty period for the PRODUCT extends for ONE (1) YEAR from the date of purchase. If the manufacturer repairs or replaces a materially defective PRODUCT under the terms of this limited warranty, this limited warranty also applies to repaired or replacement PRODUCT for a period of either (a) 90 days from the date the repaired or replacement PRODUCT is shipped to you or (b) the time remaining on the original one-year limited warranty; whichever is longer.

4. What is not covered by this limited warranty?

This limited warranty does not cover:

- PRODUCT that has been subjected to misuse, accident, shipping or other physical damage, improper installation, abnormal operation or handling, neglect, inundation, fire, water, or other liquid intrusion; or
- PRODUCT that has been damaged due to repair, alteration, or modification by anyone other than an authorized service representative of the manufacturer; or
- PRODUCT to the extent that the problem experienced is caused by signal conditions, network reliability or cable or antenna systems; or
- PRODUCT to the extent that the problem is caused by use with non-AT&T accessories; or
- PRODUCT whose warranty/quality stickers, PRODUCT serial number plates or electronic serial numbers have been removed, altered or rendered illegible; or
- PRODUCT purchased, used, serviced, or shipped for repair from outside the United States of America or Canada, or used for commercial or institutional purposes (including but not limited to products used for rental purposes); or
- PRODUCT returned without a valid proof of purchase (see item 6); or
- Charges for installation or setup, adjustment of customer controls, and installation or repair of systems outside the unit.

Limited warranty

5. How do you get warranty service?

To obtain warranty service in the United States of America, visit

www.telephones.att.com or call **1 (800) 222-3111**. In Canada, please dial **1 (866) 288-4268**.

NOTE: Before calling for service, please review the user's manual. A check of the PRODUCT controls and features might save you a service call.

Except as provided by applicable law, you assume the risk of loss or damage during transit and transportation and are responsible for delivery or handling charges incurred in the transport of the PRODUCT(s) to the service location. The manufacturer will return repaired or replaced PRODUCT under this limited warranty. Transportation, delivery or handling charges are prepaid. The manufacturer assumes no risk for damage or loss of the PRODUCT in transit. If the PRODUCT failure is not covered by this limited warranty, or proof of purchase does not meet the terms of this limited warranty, the manufacturer notifies you and requests that you authorize the cost of repair prior to any further repair activity. You must pay for the cost of repair and return shipping costs for the repair of products that are not covered by this limited warranty.

6. What must you return with the PRODUCT to get warranty service?

You must:

- a. Return the entire original package and contents including the PRODUCT to the service location along with a description of the malfunction or difficulty; and
- b. Include a "valid proof of purchase" (sales receipt) identifying the PRODUCT purchased (PRODUCT model) and the date of purchase or receipt; and
- c. Provide your name, complete and correct mailing address, and telephone number.

7. Other limitations

This warranty is the complete and exclusive agreement between you and the manufacturer of this AT&T branded PRODUCT. It supersedes all other written or oral communications related to this PRODUCT. The manufacturer provides no other warranties for this PRODUCT. The warranty exclusively describes all of the manufacturer's responsibilities regarding the PRODUCT. There are no other express warranties. No one is authorized to make modifications to this limited warranty and you should not rely on any such modification.

State/Provincial Law Rights: This warranty gives you specific legal rights, and you might also have other rights that vary from state to state or province to province.

Limitations: Implied warranties, including those of fitness for a particular purpose and merchantability (an unwritten warranty that the PRODUCT is fit for ordinary use) are limited to one year from date of purchase. Some states/provinces do not allow limitations on how long an implied warranty lasts, so the above limitation might not apply to you. In no event shall the manufacturer be liable for any indirect, special, incidental, consequential, or similar damages (including, but not limited to lost profits or revenue, inability to use the PRODUCT or other associated equipment, the cost of substitute equipment, and claims by third parties) resulting from the use of this PRODUCT. Some states/provinces do not allow the exclusion or limitation of incidental or consequential damages, so the above limitation or exclusion might not apply to you.

Please retain your original sales receipt as proof of purchase.

Technical specifications

| | |
|-----------------------|----------------------------|
| Operating temperature | 32°F — 122°F 0°C — 50°C |
| Power adapter input | AC120V 60Hz |
| Power adapter output | AC9V 300mA |
| REN | 1.2B |

Index

A

Alert tones, 44
 Announcement, 34
 Answering a call, 14
 Answering system, 34–43
 Audio Assist, 18

C

Call intercept, 39
 Call screening, 39
 Call waiting, 16
 Caller ID
 delete entries, 30
 dial entries, 30
 review entries, 29
 Chain dialing, 17

D

Date and time, 10
 Delete
 a caller ID log entry, 30
 a directory entry, 22
 a speed dial number, 24
 Dialing
 from a record in the caller ID
 history, 30
 from the directory, 22
 Dial mode, 12
 Directory, 19–25
 dial a number, 22
 edit entries, 22
 name search, 21
 new entries, 19
 Display dial, 22

E

Ending a call, 14
 Equalizer, 15

H

Home area code, 32

I

Important safety information, 52
 Indicator lights, 45

L

Language, 11, 50
 Last number redial, 15
 LCD contrast, 12
 Lights, 45
 Limited warranty, 56–57
 Line power mode, 13
 Local area codes, 32

M

Maintenance, 51
 Making a call, 14
 Memo, 41
 Memory match, 28
 Message, 40
 counter display, 42
 playback, 40–41
 Message counter displays, 42
 Mute, 16

N

Names
 enter into directory, 20, 23
 search, 21

O

On-hook dialing (predialing), 14

P

Power adapter, 4
 Predialing, 14
 Priority code, 38

Q

Quick reference guide, 1–2

R

Recording time, 39
 Redial, 15
 Remote access, 43

S

Screen angle, 5
 Screen icons, 44
 Speakerphone, 14

Index

Speed dial

- assign a number, 24
- delete a number, 24
- dial a number, 25
- enter a number, 23
- review a number, 25

T

- Tabletop installation, 8
- Technical specifications, 58
- Telephone installation, 4
- Temporary tone dialing, 18
- Troubleshooting, 47–50

V

- Voice prompts, 39
- Volume control
 - handset, 16, 40
 - telephone base, 16, 40

W

- Wall-mount installation, 6
- Warranty, 56–57

Remote access wallet card

The following wallet card lists the commands needed to control your answering system from any touch-tone telephone.

Cut along dotted line.



Call your telephone number, then enter your three-digit remote access code (preset to **500**).

| Action | Remote command |
|-----------------------------------------|------------------------------------|
| Play all messages | 1 |
| Play new messages..... | 2 |
| Delete the message..... | 3 (during message playback) |
| Delete all old messages | *3 |
| Repeat current or previous message..... | 4 |
| Stop..... | 5 |
| Skip the message..... | 6 |
| Play announcement | 7 |
| Record new announcement... | 8 |
| Turn system on or off | 0 |

Fold here.

CL4940 Big button/big display telephone/answering system with caller ID/call waiting

© 2011-2014 Advanced American Telephones. All Rights Reserved.
AT&T and the AT&T logo are trademarks of AT&T Intellectual Property licensed to Advanced American Telephones, San Antonio, TX 78219.
Printed in China.



www.telephones.att.com

Audio Assist® and Message Guard® are registered trademarks of Advanced American Telephones.

© 2011-2014 Advanced American Telephones. All Rights Reserved.
AT&T and the AT&T logo are trademarks of AT&T Intellectual Property licensed to
Advanced American Telephones, San Antonio, TX 78219.
Printed in China. Issue 11.0 AT&T 12/14.