



at&t



Proud Sponsor

User's manual

CL81109/CL81209/

CL81219/CL81309

DECT 6.0 cordless

**telephone with caller ID/
call waiting**



Congratulations

on your purchase of this AT&T product. Before using this AT&T product, please read the **Important safety information** on pages 51-52 of this manual. Please thoroughly read this user's manual for all the feature operations and troubleshooting information necessary to install and operate your new AT&T product. You can also visit our website at **www.telephones.att.com** or call **1 (800) 222-3111**. In Canada, dial **1 (866) 288-4268**.

Model #: CL81109 (one handset)
 CL81209 (two handsets)
 CL81219 (two handsets)
 CL81309 (three handsets)

Type: DECT 6.0 cordless telephone with caller ID/call waiting

Serial #: _____

Purchase date: _____

Place of purchase: _____

Both the model and serial number of your AT&T product can be found on the bottom of the telephone base.

Save your sales receipt and original packaging in case it is necessary to return your telephone for warranty service.



Telephones identified with this logo have reduced noise and interference when used with most T-coil equipped hearing aids and cochlear implants. The TIA-1083 Compliant Logo is a trademark of the Telecommunications Industry Association. Used under license.



The ENERGY STAR program® (www.energystar.gov) recognizes and encourages the use of products that save energy and help protect our environment. We are proud to mark this product with the ENERGY STAR® label indicating it meets the latest energy efficiency guidelines.

Parts checklist

Your telephone package contains the following items. Save your sales receipt and original packaging in the event warranty service is necessary.

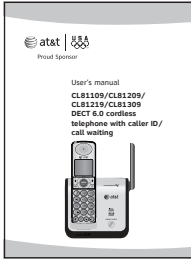

User's manual

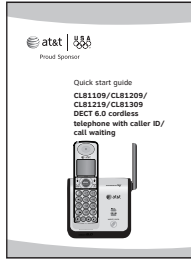

Quick start guide



Cordless handset
CL81109 (one handset)
CL81209 (two handsets)
CL81219 (two handsets)
CL81309 (three handsets)



Telephone base



Charger for cordless handset with power adapter installed
(One for CL81209)
(One for CL81219)
(Two for CL81309)

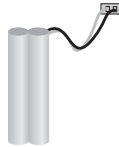

Battery for cordless handset
(One for CL81109)
(Two for CL81209)
(Two for CL81219)
(Three for CL81309)



Battery compartment cover
(One for CL81109)
(Two for CL81209)
(Two for CL81219)
(Three for CL81309)

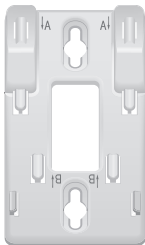

Wall-mount bracket

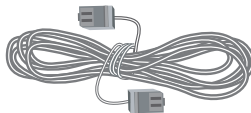

Telephone line cord

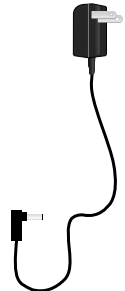

Power adapter for telephone base

User's manual

CL81109/CL81209/ CL81219/CL81309 DECT 6.0 cordless telephone with caller ID/ call waiting



Table of contents

Getting started

| | |
|--|---|
| Quick reference guide - handset..... | 1 |
| Quick reference guide - telephone base..... | 3 |
| Installation..... | 4 |
| Telephone base installation..... | 5 |
| Charger installation..... | 6 |
| Battery installation & charging..... | 7 |
| Installation options..... | 9 |

Handset settings

| | |
|--|----|
| Telephone settings..... | 11 |
| MENU settings..... | 11 |
| Ringer volume..... | 11 |
| Ringer tone..... | 12 |
| Key tone..... | 12 |
| LCD Language..... | 12 |
| Set date/time..... | 13 |
| Voicemail (visual message waiting) indicator..... | 14 |
| Clear voicemail indication..... | 14 |
| Home area code..... | 15 |

Telephone operation

| | |
|---|----|
| Making, answering, and ending calls..... | 16 |
| Making a call..... | 16 |
| On-hook dialing (predialing)..... | 16 |
| Answering a call..... | 16 |
| Temporary ringer silencing..... | 16 |

| | |
|-----------------------------|----|
| Ending a call..... | 16 |
| Auto off..... | 16 |
| Handset operation..... | 17 |
| Speakerphone..... | 17 |
| Last number redial..... | 17 |
| Options while on calls..... | 18 |
| Volume control..... | 18 |
| Call waiting..... | 18 |
| Mute..... | 18 |
| Chain dialing..... | 19 |

Multiple handset use

| | |
|-----------------------------------|----|
| Multiple handset use..... | 20 |
| Handset locator..... | 20 |
| Join a call in progress..... | 20 |
| Intercom..... | 21 |
| Call transfer using intercom..... | 23 |

Directory

| | |
|--------------------------------------|----|
| About the directory..... | 24 |
| Shared directory..... | 24 |
| Capacity..... | 24 |
| Exiting the directory..... | 24 |
| Create directory entries..... | 25 |
| To create a new directory entry..... | 25 |
| Review directory..... | 27 |
| To review directory entries..... | 27 |
| Search directory..... | 28 |
| To search by name..... | 28 |
| To dial, delete or edit entries..... | 29 |
| Display dial..... | 29 |

| | |
|-------------------------|----|
| To delete an entry..... | 29 |
| To edit an entry..... | 29 |

Caller ID

| | |
|--|----|
| About caller ID..... | 30 |
| Information about caller ID with call waiting..... | 30 |
| Caller ID history..... | 31 |
| How the caller ID history (call log) works..... | 31 |
| Memory match..... | 32 |
| Missed (new) calls indicator..... | 32 |
| To review the caller ID history..... | 33 |
| Make a call log entry ready to dial..... | 33 |
| Dial a call log entry..... | 34 |
| Delete entries..... | 34 |
| Save a call log entry to the directory..... | 34 |
| Reasons for missing caller ID information..... | 35 |

Appendix A

| | |
|-----------------------------|----|
| Alert tones and lights..... | 36 |
| Screen icons..... | 36 |
| Handset alert tones..... | 36 |
| Lights..... | 36 |

Appendix B

| | |
|-------------------------------------|----|
| Handset display screen messages.... | 37 |
|-------------------------------------|----|

Appendix C

| | |
|---|----|
| Expansion handset..... | 39 |
| To register a handset to your telephone base..... | 40 |
| To deregister all handsets..... | 41 |

Appendix D

| | |
|----------------------|----|
| Troubleshooting..... | 42 |
|----------------------|----|

Appendix E

| | |
|------------------|----|
| Maintenance..... | 50 |
|------------------|----|

Appendix F

| | |
|--|----|
| Important safety information..... | 51 |
| Safety information..... | 51 |
| Especially about cordless telephones..... | 52 |
| Precautions for users of implanted cardiac pacemakers..... | 52 |
| Pacemaker patients..... | 52 |

Appendix G

| | |
|---------------------------|----|
| FCC Part 68 and ACTA..... | 53 |
|---------------------------|----|

Appendix H

| | |
|------------------|----|
| FCC Part 15..... | 55 |
|------------------|----|

Appendix I

| | |
|-----------------------|----|
| Limited warranty..... | 56 |
|-----------------------|----|

Appendix J

| | |
|---|----|
| Technical specifications..... | 58 |
| DECT 6.0 digital technology..... | 58 |
| Telephone operating range..... | 58 |
| Redefining long range coverage and clarity..... | 58 |

| | |
|------------|----|
| Index..... | 59 |
|------------|----|

Quick reference guide - handset

CHARGE indicator

On when the handset is charging in the telephone base or charger.

▼CID/-VOLUME

Press ▼CID to display caller ID history (page 33).

Press to scroll down while in menus.

While entering names or numbers, press to move the cursor to the left.

Press to decrease the listening volume when on a call.

☎PHONE/FLASH

Press to make or answer a call.

During a call, press to answer an incoming call when you receive a call waiting alert (page 18).

1

While reviewing a call log entry, press repeatedly to add or remove 1 in front of the telephone number before dialing or saving it in the directory.

MUTE/DELETE

During a call, press to mute the microphone (page 18).

While reviewing the caller ID history, the directory or the redial memory, press to delete an individual entry (page 34, page 29 and page 17 respectively).

While predialing, press to delete digits (page 16).

🔊SPEAKER

Press to switch between speakerphone and handset.



MENU/SELECT

Press to show the menu.

While in the menu, press to select an item or save an entry or setting.

DIR▲/+VOLUME

Press DIR▲ to show directory entries (page 27).

Press to scroll up while in menus.

While entering names or numbers, press to move the cursor to the right.

Press to increase the listening volume when on a call.

☎OFF/CLEAR

During a call, press to hang up.

While in a menu, press to cancel an operation, back up to the previous menu, or exit the menu display.

Press and hold while the telephone is not in use to erase the missed calls indicator.

#

Press repeatedly to display other dialing options when reviewing a call log entry.

REDIAL/PAUSE

Press repeatedly to view the last five numbers dialed (page 17).

While entering numbers, press and hold to insert a dialing pause (page 25).

INT

Press to begin an intercom conversation or to transfer a call (pages 21-23).

Main menu

The > symbol highlights a menu item.

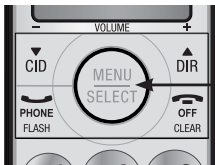

Main menu

- DIRECTORY (page 24)
- CALL LOG (page 30)
- RINGER VOLUME (page 11)
- RINGER TONE (page 12)
- KEY TONE (page 12)
- LCD LANGUAGE (page 12)
- SET DATE/TIME (page 13)
- CLR VOICEMAIL (page 14)
- HOME AREA CODE (page 15)

Using menus

Press **MENU/SELECT** to show the first menu item, **DIRECTORY**.

Press **▼CID** or **DIR▲** to scroll through menu items.

Press **MENU/SELECT** to select or save changes to a highlighted menu item.

Press **OFF/CLEAR** to cancel an operation, back up to the previous menu, or exit the menu display.

Quick reference guide - telephone base

IN USE indicator

On when the handset is in use or when you are registering a handset.

Flashes when another telephone is in use on the same line, or when you are deregistering handset(s) from the telephone base.

Flashes quickly when there is an incoming call.

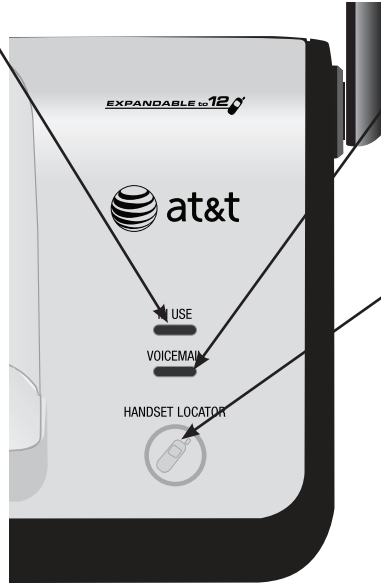

VOICEMAIL indicator

Flashes when you have new voicemail. Voicemail service is offered by your telephone service provider (page 14).

HANDSET LOCATOR

Press to make handsets beep so you can locate them (page 20).

You must install and charge the battery before using the telephone.



See pages 7-8
for easy instructions.

Install the telephone base close to a telephone jack and a power outlet not controlled by a wall switch. The telephone base can be placed on a flat surface or vertically mounted on the wall (see page 9). For optimum range and better reception, place the telephone base in a central and open location.

If you subscribe to high-speed Internet service (digital subscriber line - DSL) through your telephone line, you must install a DSL filter between the telephone line cord and the telephone wall jack (see the following page). The filter prevents noise and caller ID problems caused by DSL interference. Please contact your DSL service provider for more information about DSL filters.

Your product may be shipped with a protective sticker covering the handset or telephone base display - remove it before use.

For customer service or product information, visit our website at www.telephones.att.com or call **1 (800) 222-3111**. In Canada, dial **1 (866) 288-4268**.

Avoid placing the telephone base too close to:

- Communication devices such as: television sets, VCRs, or other cordless telephones.
- Excessive heat sources.
- Noise sources such as a window with traffic outside, motors, microwave ovens, refrigerators, or fluorescent lighting.
- Excessive dust sources such as a workshop or garage.
- Excessive moisture.
- Extremely low temperature.
- Mechanical vibration or shock such as on top of the washing machine or workbench.

Telephone base installation

Install the telephone base as shown below.

The telephone base is ready for tabletop use. If you want to change to wall-mounting installation, see page 9 for details.

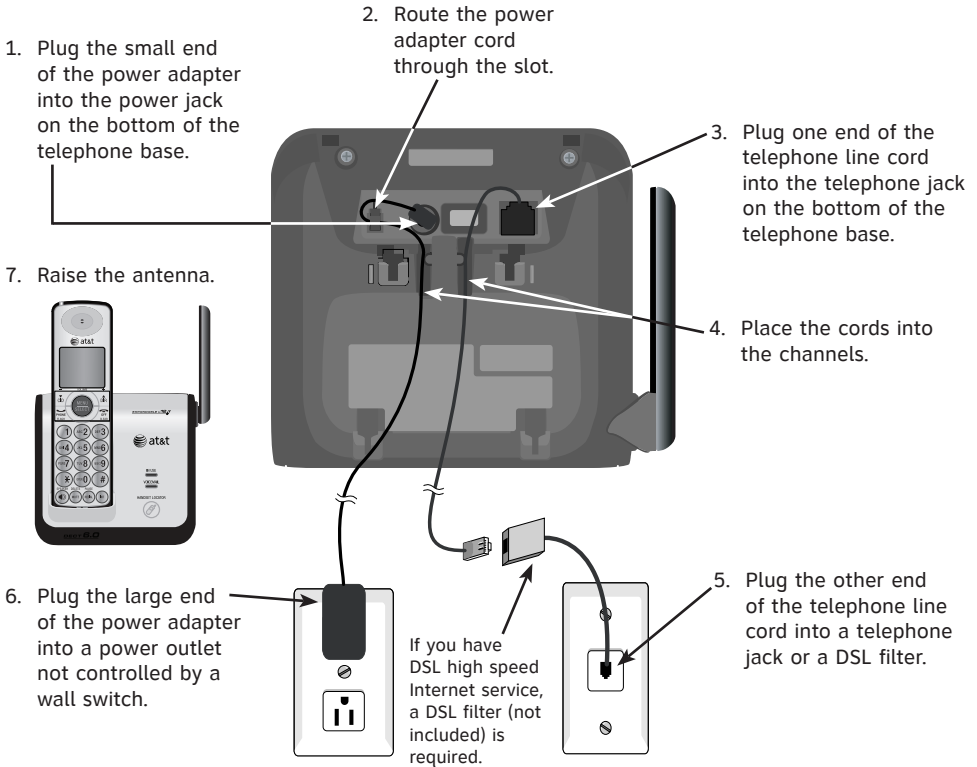

IMPORTANT INFORMATION

1. Use only the power adapter(s) supplied with this product. To order a replacement power adapter, visit our website at www.telephones.att.com or call **1 (800) 222-3111**. In Canada, dial **1 (866) 288-4268**.
2. The power adapters are intended to be correctly oriented in a vertical or floor mount position. The prongs are not designed to hold the plug in place if it is plugged into a ceiling, under-the-table or cabinet outlet.

Getting started

Charger installation

Install the charger as shown below.

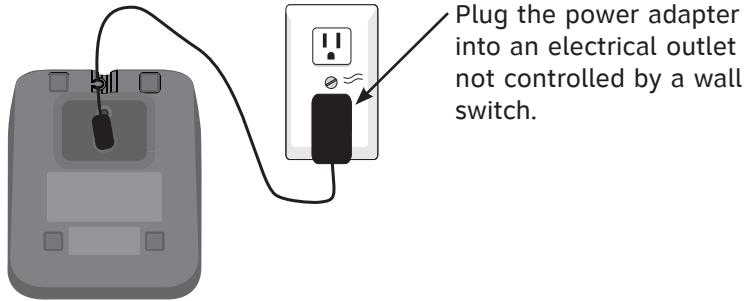

Plug the power adapter into an electrical outlet not controlled by a wall switch.



IMPORTANT INFORMATION

1. Use only the power adapter(s) supplied with this product. To order a replacement power adapter, visit our website at **www.telephones.att.com**, or call **1 (800) 222-3111**. In Canada, dial **1 (866) 288-4268**.
2. The power adapters are intended to be correctly oriented in a vertical or floor mount position. The prongs are not designed to hold the plug in place if it is plugged into a ceiling, under-the-table or cabinet outlet.

Battery installation & charging

Install the battery as shown on the next page. Once you have installed the battery, the screen indicates the battery status (see table below). If necessary, place the handset in the telephone base or charger to charge the battery. For best performance, keep the handset in the charger when not in use. The battery is fully charged after 16 hours of continuous charging. See the table on page 58 for battery operating times.

If the screen is blank, you need to charge the handset without interruption for at least 30 minutes to give the handset enough charge to use the telephone for a short time. The screen shows **LOW BATTERY** and the backlight is off until you have charged the battery without interruption for at least one hour. The following table summarizes the battery charge indicators and actions to take.

| Battery indicators | Battery status | Action |
|---|---|--|
| The screen is blank or shows PLACE IN CHARGER and  flashes. | Battery has little or no charge and the handset cannot be used. | Charge without interruption until the screen shows LOW BATTERY (at least 30 minutes). |
| The screen shows LOW BATTERY and  flashes. | Battery has enough charge to be used for a short time. | Charge without interruption until the screen shows HANDSET X (at least one hour). |
| The screen shows HANDSET X . | Battery is charged. | To keep the battery charged, place it in the telephone base or charger when not in use. |

 **NOTE:** If you are on a phone call in low battery mode, you hear four short beeps every minute.

Battery installation & charging



Step 1

Plug the battery connector securely into the socket inside the handset battery compartment, matching the color-coded label. Insert the supplied battery with the label **THIS SIDE UP** facing up as indicated.



Step 2

Align the cover flat against the battery compartment, then slide it upwards until it clicks into place.

Step 3

Charge the handset by placing it face forward in the telephone base or charger. The **CHARGE** light is on when charging.

CHARGE light



IMPORTANT INFORMATION

1. Use only the supplied rechargeable battery or replacement battery (model BT8001). To order, visit our website at **www.telephones.att.com** or call **1 (800) 222-3111**. In Canada, dial **1 (866) 288-4268**.
2. If you do not use the handset for a long time, disconnect and remove the battery to prevent possible leakage.

Installation options

Your telephone base is ready for tabletop use. If you want to mount your telephone on a wall, use the provided wall-mount bracket to connect with a standard dual-stud telephone wall-mounting plate. If you do not have this mounting plate, you can purchase one from many hardware or consumer electronic retailers. You might need a professional to install the mounting plate.

Tabletop to wall installation

1. Position the telephone base as shown below. Insert the extended tabs (marked **A**) of the wall-mount bracket into the slots on the back of the telephone base (marked **A**). Push the telephone base down until it is securely in place.
2. If you are using a DSL filter, plug the line cord into the filter now. Route the telephone line cord (or DSL filter) through the wall-mount bracket hole. Route the power cord out of the bottom of the telephone.

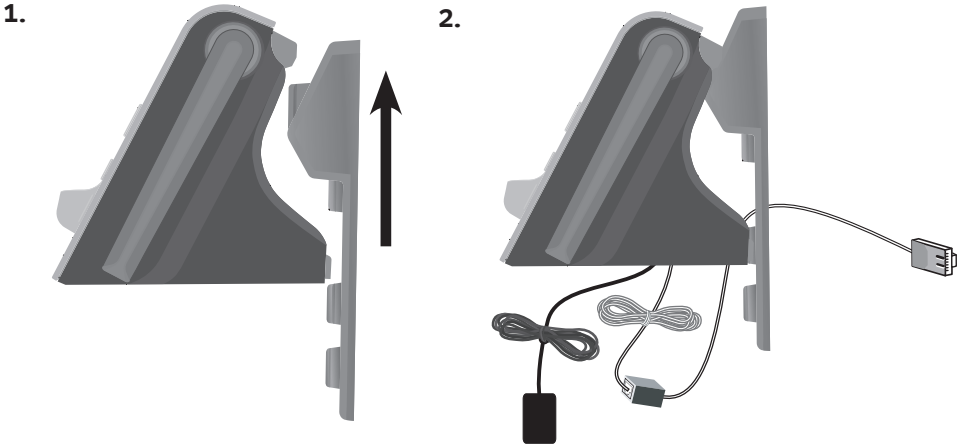

Installation options

3. Plug the telephone line cord (or DSL filter) into the wall jack. Plug the power adapter into a power outlet not controlled by a wall switch.
4. Align the holes on the wall-mount bracket with the standard wall plate and slide the wall-mount bracket down until it locks securely. Bundle the telephone line cord and power adapter cord neatly with a twist tie.

3.

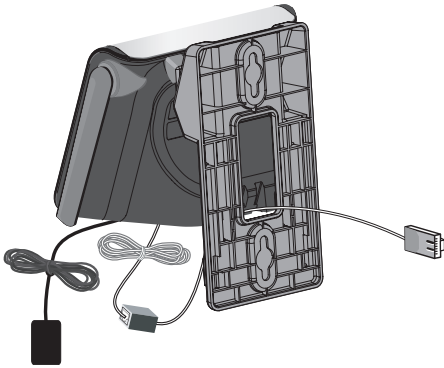

4.

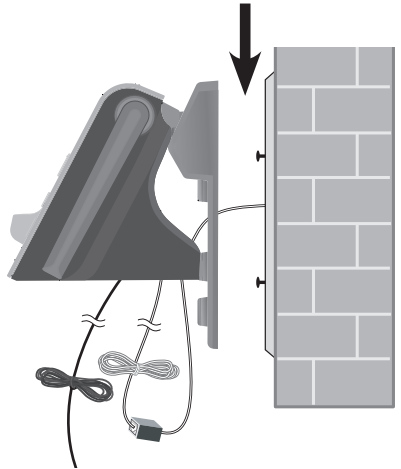

Wall to tabletop installation

1. If the telephone line cord and power adapter cord are bundled, untie them first.
2. Push the telephone base up to detach it from the wall-mount bracket. Unplug the telephone line cord (or DSL filter) from the wall. Unplug the power adapter from the power outlet.
3. See **Telephone base & charger installation** on pages 5-6.

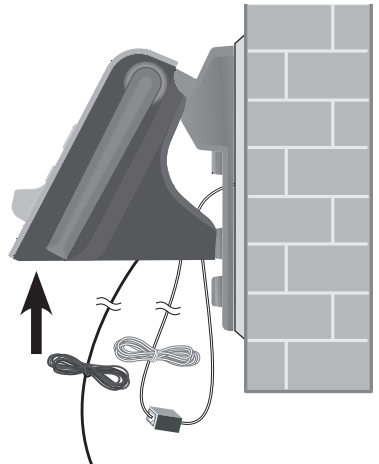

Telephone settings

MENU settings

Use the menus to change the telephone's settings.

1. Press **MENU/SELECT** when in idle mode (when the phone is not in use) to enter the main menu.
2. Press **▼CID** or **DIR▲** to scroll to the feature to be changed. When scrolling through the menu, the top menu item is always highlighted with a > symbol.
3. Press **MENU/SELECT** to select the highlighted item.



i **NOTE:** Press **OFF/CLEAR** to cancel an operation, back up to the previous menu or exit the menu display. Press and hold **OFF/CLEAR** to return to idle mode.

Ringer volume

You can set the ringer volume level (1-6), or turn the ringer off. When the ringer is off,  appears on the handset screen.

1. Press **MENU/SELECT** in idle mode to enter the main menu.
2. Use **▼CID** or **DIR▲** to scroll to **>RINGER VOLUME**, then press **MENU/SELECT**.
3. Press **▼CID** or **DIR▲** to sample each volume level.
4. Press **MENU/SELECT** to save your preference and return to the main menu.

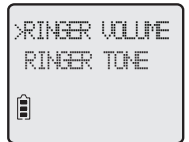

i **NOTE:** The ringer volume also determines the ringer volume of the intercom calls (page 21) and the paging tone for the handset locator (page 20). If the handset ringer volume is set to off, that handset is silenced for all incoming calls and paging.

Telephone settings

Ringer tone

You can choose one of 10 ringer tones.

1. Press **MENU/SELECT** in idle mode to enter the main menu.
2. Use **▼CID** or **DIR▲** to scroll to **>RINGER TONE**, then press **MENU/SELECT**.
3. Press **▼CID** or **DIR▲** to sample each ringer tone.
4. Press **MENU/SELECT** to save your preference and return to the main menu.

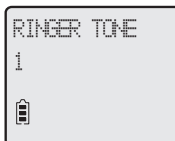
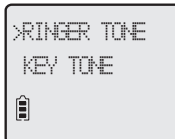

NOTE: If you turn off the ringer volume, you do not hear ringer tone samples.

**Key tone**

The handset is factory programmed to beep with each key press. If you turn off the **KEY TONE**, there are no beeps when you press keys.

1. Press **MENU/SELECT** in idle mode to enter the main menu.
2. Use **▼CID** or **DIR▲** to scroll to **>KEY TONE**, then press **MENU/SELECT**.
3. Press **▼CID** or **DIR▲** to select **ON** or **OFF**.
4. Press **MENU/SELECT** to save your preference and return to the main menu.

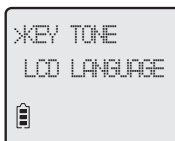
**LCD Language**

You can select the language used for all screen displays.

1. Press **MENU/SELECT** in idle mode to enter the main menu.
2. Use **▼CID** or **DIR▲** to scroll to **>LCD LANGUAGE**, then press **MENU/SELECT**.
3. Press **▼CID** or **DIR▲** to select **ENGLISH**, **FRANCAIS** or **ESPANOL**.
4. Press **MENU/SELECT** to save your preference and return to the main menu.

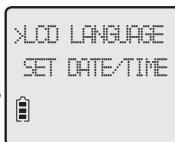

Telephone settings

If you subscribe to caller ID service, the day, month and time are set automatically with each incoming call.

Set date/time

Follow the steps below to set the month, day, year and time.

1. When the handset is in idle mode, press **MENU/SELECT** to enter the main menu.
2. Press **▼CID** or **DIR▲** to scroll to **>SET DATE/TIME**, then press **MENU/SELECT**.
3. Press **▼CID** or **DIR▲** to select the month, or enter the correct number using the dial pad, then press **MENU/SELECT** to confirm.
4. Press **▼CID** or **DIR▲** to select the day, or enter the correct number using the dial pad, then press **MENU/SELECT** to confirm.
5. Press **▼CID** or **DIR▲** to select the year, or enter the correct number using the dial pad, then press **MENU/SELECT** to confirm.
6. Press **▼CID** or **DIR▲** to select the hour, or enter the correct number using the dial pad, then press **MENU/SELECT** to confirm.
7. Press **▼CID** or **DIR▲** to select the minute, or enter the correct number using the dial pad, then press **MENU/SELECT** to confirm.
8. Press **▼CID** or **DIR▲** to select the **AM** or **PM**, then press **MENU/SELECT** to confirm. There is a confirmation tone.



Telephone settings

Voicemail (visual message waiting) indicator

If you subscribe to a voicemail service offered by your telephone service provider, this feature provides a visual indication when you have new voicemail messages. The **VOICEMAIL** light on the telephone base flashes, and **NEW VOICEMAIL** and the  icon appear on the handset screen.

**Clear voicemail indication**

Use this feature when the telephone indicates there is new voicemail but there is none. For example, when you have accessed your voicemail while away from home. This feature only turns off the displayed **NEW VOICEMAIL** message,  icon, and **VOICEMAIL** light; it does not delete your voicemail messages. As long as you have new voicemail messages, your telephone service provider continues to send the signal to turn on the indicator.

To manually turn off the new voicemail indicator:

1. Press **MENU/SELECT** when in idle mode to enter the main menu.
2. Use **▼CID** or **DIR▲** to scroll to **>CLR VOICEMAIL**, then press **MENU/SELECT**, the screen shows **TURN OFF INDICATOR?**
3. Press **MENU/SELECT** again to turn the voicemail indication off, or press  **OFF/CLEAR** to cancel the procedure.

**NOTES:**

1. Telephone company voicemail might alert you to new messages with a stutter (broken) dial tone. Contact your telephone company for more details.
2. For information about using your voicemail service, contact your telephone company for assistance.

Telephone settings

Home area code

If you dial seven digits to make a local call (no area code required), enter your area code into the telephone as the home area code. When you receive a call from within your home area code, the caller ID history only displays the seven digits of the telephone number.

This feature makes it easy for you to place a call from the caller ID log. If you dial 10 digits to make a local phone call, do not use this home area code feature. If you do, you cannot place calls from your caller ID log as they have only seven digits.

1. Press **MENU/SELECT** in the idle mode to enter the main menu.
2. Use **▼CID** or **DIR▲** to scroll to **>HOME AREA CODE**, then press **MENU/SELECT**.
3. Use the dial pad keys to enter a three-digit home area code. Press **MUTE/DELETE** to delete digits while entering.
4. Press **MENU/SELECT** to save and return to the main menu.

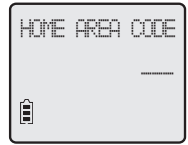
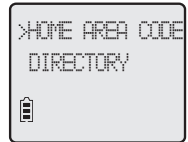



NOTE: If, in the future, your telephone service provider requires you to dial 10 digits to make a local call (area code + phone number). With the home area code displayed, press and hold MUTE/DELETE. The home area code is now restored to its default setting of _ _ _.

Making, answering, and ending calls

Making a call

To make a call:

- Press  **PHONE/FLASH** or  **SPEAKER**, then enter the telephone number.

The screen displays the elapsed time as you talk (in hours, minutes and seconds).

Elapsed time





NOTE: Pressing  **PHONE/FLASH** to access services from your telephone service provider does not affect the elapsed time.

On-hook dialing (predialing)

Enter the telephone number, then press  **PHONE/FLASH** or  **SPEAKER** to dial. Press **MUTE/DELETE** or  **OFF/CLEAR** at any time to make corrections when entering the phone number.

Answering a call

To answer a call:

- Press  **PHONE/FLASH** or  **SPEAKER**.
- OR-
- Press any dial pad key (0-9, * or #).

Temporary ringer silencing

Press  **OFF/CLEAR** or **MUTE/DELETE** while the telephone is ringing to silence the ringer temporarily on that handset only. This turns off the ringer without disconnecting the call. The next incoming call rings normally at the preset volume.



NOTE: Each handset rings when there is an incoming call unless the ringer volume is turned off on that handset.

Ending a call



Press  **OFF/CLEAR** or return the handset to the telephone base or charger.

Auto off

A call ends automatically when you put the handset in the telephone base or charger.

Handset operation

Speakerphone

During a call, press  **SPEAKER** to switch between hands-free speakerphone and normal handset use. Press  **OFF/CLEAR** to hang up.



NOTES:

1. If you use the speakerphone during **LOW BATTERY** mode, the handset is not lit except for the  **SPEAKER** button.
2. The speakerphone uses more power than the normal handset. If the handset battery becomes very low while you are using the speakerphone, the call remains in speakerphone mode until you hang up or the battery becomes depleted. When the battery is very low, you cannot switch a call from normal handset use to speakerphone mode.
3. After installing the battery into the handset, the screen may show **LOW BATTERY**. If you use speakerphone at this time, the battery may become depleted. Follow the instructions in the **Battery installation & charging** section on pages 7-8.

Last number redial

To view the five most recently dialed numbers:





- To display the most recently called number (up to 30 digits), press **REDIAL/PAUSE**.
- To view up to five recently called numbers, press **REDIAL/PAUSE** then **▼CID** or **DIR▲**, or press **REDIAL/PAUSE** repeatedly.



The handset beeps twice at the beginning and at the end of the list.

Press  **OFF/CLEAR** to exit.

To redial a number:

- To dial the displayed number, press  **PHONE/FLASH** or  **SPEAKER**.
- OR-
- You can call the most recently called number by pressing  **PHONE/FLASH** or  **SPEAKER**, then pressing **REDIAL/PAUSE**.

While reviewing the redial memory, press **MUTE/DELETE** to delete the displayed number.

Options while on calls

Volume control

While on a call, press **VOLUME-/▼CID** to decrease or press **VOLUME+/DIR▲** to increase the listening volume.



NOTES:

1. Handset and speakerphone volume settings are independent.
2. When the volume reaches the minimum or maximum setting, you hear two beeps.

VOLUME-/▼CID or
VOLUME+/DIR▲



Call waiting

If you subscribe to call waiting service with your telephone service provider, you hear a beep if someone calls while you are already on a call.

Press **PHONE/FLASH** to put your current call on hold and take the new call. Press **PHONE/FLASH** at any time to switch back and forth between calls.

Mute

Use the mute function to turn off the microphone. You can hear the caller, but the caller does not hear you.

To mute a call:

- Press **MUTE/DELETE**. When mute is on, the handset screen shows **MUTED** for a few seconds and the **MUTE** icon appears until you turn off mute.

To un-mute a call:

- Press **MUTE/DELETE** again. When mute is off, **MICROPHONE ON** appears temporarily on the handset screen.



MUTE/DELETE



Options while on calls

Chain dialing

Use this feature to initiate a dialing sequence from the numbers in the directory, caller ID history or redial memory while you are on a call.

Chain dialing can be useful if you wish to access other numbers (such as bank account information or access codes) from the directory, caller ID history or redial list.

To access the directory while on a call:

1. Press **MENU/SELECT** twice.
2. Press **▼CID** or **DIR▲** to scroll to the desired number.
3. Press **MENU/SELECT** to dial the number shown.

To access the caller ID history (call log) while on a call:

1. Press **MENU/SELECT**.
2. Press **▼CID** or **DIR▲** to scroll to **>CALL LOG**, then press **MENU/SELECT**.
3. Press **▼CID** or **DIR▲** to scroll to the desired number.
4. Press **MENU/SELECT** to dial the number shown.

To access the last number redial while on a call:

Press **REDIAL/PAUSE** to show and dial the most recently dialed number. If you press **REDIAL/PAUSE** again within two seconds, the system does not dial the number.



NOTES:

1. You cannot edit a directory entry while on a call. For more details about the directory, see page 24.
2. You cannot copy a caller ID entry into the directory while on a call. For more details about the caller ID history, see page 30.
3. If you press **REDIAL/PAUSE** while on a call, you can only view the most recent call, and you cannot erase the entry. For more details about the redial memory, see page 17.
4. Press and hold  **OFF/CLEAR** to exit redial, directory or caller ID history when on a call.

Multiple handset use

Handset locator

The handset locator feature is useful if you misplace any handset.

To start the paging tone:

- Press  **HANDSET LOCATOR** at the telephone base to start the paging tone on all handsets for 60 seconds.



NOTE: If you press  **OFF/CLEAR** or **MUTE/DELETE** on a handset, the ringer of the handset is off, but the page tone does not stop.

To stop the paging tone:

- Press  **PHONE/FLASH**,  **SPEAKER**, or any dial pad key (0-9, *, or #) on the handset(s).

–OR–



- Press  **HANDSET LOCATOR** on the telephone base.



NOTE: The handset ringer volume also determines the volume of the paging tone. If the handset ringer volume level is set to off, that handset is silent for all calls and paging (page 11).



Join a call in progress (not available on model CL81109)

You can conference with another system handset while on a call. If a handset is already on a call and you would like to join the call, press  **PHONE/FLASH** or  **SPEAKER** on another system handset.

Press  **OFF/CLEAR** or place the handset in the telephone base or charger to end the call. The call does not terminate until all handsets hang up.



NOTE: You can only use two system handsets at the same time on an outside call.

Intercom

Use the intercom feature for conversations between handsets. This feature is not available for model CL81109 unless you have purchased additional handsets (CL80109).

You can buy additional expansion handsets (model AT&T CL80109) for this telephone base. You can register up to 12 handsets to the telephone base.



The first nine handsets that you register are named Handsets 1-9. Use the handset number to initiate intercom and transfer calls.

Although the names for handsets 10-12 appears in their displays as 10-12, when you intercom or transfer to one of them, you must use ***0** for Handset 10, ***1** for handset 11, and ***2** for Handset 12.

1. Press **INT** on your handset when not in use.

- If you have a two-handset system, your handset screen shows **CALLING OTHER HANDSET**.
- If you have more than two handsets, your screen shows **INTERCOM TO:** Use the dialing keys to enter a handset number. Your handset screen shows **CALLING HANDSET X**.



The other handset rings and its screen shows either **OTHER HANDSET IS CALLING** or **HANDSET X IS CALLING**.

2. To answer the intercom call, press  **PHONE/FLASH**, **INT**,  **SPEAKER** or any dial pad keys (0-9, #, *) on the other handset. Both handsets now show **INTERCOM**.

3. To end an intercom call, press **INT**,  **OFF/CLEAR**, or place the handset back in the telephone base or charger.





NOTES:

1. Before the intercom call is answered, you can cancel the intercom call by pressing  **OFF/CLEAR** or **INT** on the calling handset.
2. If the called handset is not answered within 100 seconds, or if it is in the directory or call log mode, or is on a call, or is out of range, the calling handset shows the message **UNABLE TO CALL TRY AGAIN**.
3. Pressing  **OFF/CLEAR** or **MUTE/DELETE** temporarily silences the intercom ringer.
4. You can use a maximum of four handsets at a time. When you use two handsets on an intercom call, others can use two other system handsets for an outside call.

Intercom

Answer an incoming call during an intercom call

If you receive an incoming outside call during an intercom call, there is an alert tone.

- To answer the call, press  **PHONE/FLASH**. The intercom call ends automatically.
- To end the intercom call without canceling the incoming call, press  **OFF/CLEAR**.

Call transfer using intercom

Use the intercom feature to transfer an outside call to another system handset. This feature is not available for model CL81109 unless you have purchased additional handsets (CL80109).

1. During a call, press **INT**.

- If you have a two-handset system, the outside call is put on hold and your handset screen shows **CALLING OTHER HANDSET**. The other handset rings and its screen shows **OTHER HANDSET IS CALLING**.
- If you have more than two handsets, your screen shows **TRANSFER TO:** Use the dialing keys to enter a handset number. The outside call is put on hold and your handset screen shows **CALLING HANDSET X**. The other handset rings and its screen shows **HANDSET X IS CALLING**.

2. To answer the call on the other handset, press **PHONE/FLASH, INT, (M) SPEAKER** or any dial pad keys (0-9, #, *). The outside call is still on hold and both handsets now show **INTERCOM**. You can now have a private conversation between the system handsets.



NOTES:

1. To cancel the transfer and return to the external call before the intercom call is answered, press and hold **OFF/CLEAR**, or press **PHONE/FLASH** or **INT** on your handset.
 2. If the other handset does not answer the intercom call within 100 seconds, or if the other handset is in the directory or call log mode, or is out of range, the calling handset shows **UNABLE TO CALL TRY AGAIN** on its screen and automatically returns to the external call.
3. From this intercom call, you have the following options:
- You can let the other handset join you on the outside call in a three-way conversation. Press and hold **INT** on the calling handset.
 - You can transfer the call. Press **OFF/CLEAR**, or place your handset back in the telephone base or charger. Your screen shows **CALL TRANSFERED**. The other handset automatically connects to the outside call.
 - You can alternate between the outside call (**OUTSIDE CALL** appears on the screen) and the intercom call (**INTERCOM** appears on the screen). Press **INT** on your handset to alternate.
 - The other person can end the intercom call by pressing **OFF/CLEAR**, or by placing the other handset back in the telephone base or charger. The outside call continues with the original system handset.

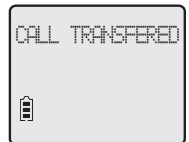

About the directory

Shared directory

The directory is in the telephone base and is common for all handsets. Changes made to the directory from any handset apply to all.



NOTE: Only one handset can review the directory at a time. If another handset tries to enter the directory, the screen shows **NOT AVAILABLE AT THIS TIME**.



Capacity

The directory can store up to 50 entries, with a maximum of 15 alphanumeric characters (including spaces) for names and 30 digits for telephone numbers. A convenient search feature can help you find and dial numbers quickly (page 28).

If there are already 50 entries, the screen shows **LIST FULL**. You cannot store a new number until you delete one.

Exiting the directory

Press **OFF/CLEAR** to cancel an operation, back up to the previous menu, or exit the menu display. Press and hold **OFF/CLEAR** to return to the idle mode.

If you pause for too long while creating or reviewing an entry, the procedure times out and you have to begin again.

Create directory entries

To create a new directory entry

1. Press **MENU/SELECT** in idle mode to enter the main menu.
2. Press **MENU/SELECT** again to enter **>DIRECTORY**.
3. Press **▼CID** or **DIR▲** to highlight **STORE**.
4. Press **MENU/SELECT**.
5. Enter the telephone number when prompted.

- Use the dial pad to enter up to 30 digits.
 - Press **▼CID** or **DIR▲** to move the cursor to the left or right.
 - Press **MUTE/DELETE** to erase digits.
 - Press and hold **MUTE/DELETE** to erase all digits.
 - Press and hold **REDIAL/PAUSE** to enter a three-second dialing pause (a **p** appears).

-OR-

- Copy a number from the redial list by pressing **REDIAL/PAUSE** then **▼CID** or **DIR▲**, or pressing **REDIAL/PAUSE** repeatedly to locate the number to copy. Press **MENU/SELECT** to copy the number.

6. Press **MENU/SELECT** to save the number in the display.

The display shows **ALREADY SAVED** if the number is already in the directory. You cannot save the same number twice.



Create directory entries

7. Enter the name when prompted.

- Use the dial pad to enter a name (up to 15 characters). Each time you press a key, the character on that key appears. Additional key presses produce other characters on that key. See the chart below.
 - Press **▼CID** or **DIR▲** to move the cursor to the left or right.
 - Press **MUTE/DELETE** to erase characters.
 - Press and hold **MUTE/DELETE** to erase all characters.



| Number key | Characters by number of key presses | | | | | | | | |
|------------|-------------------------------------|---|---|---|---|---|---|---|---|
| | 1 | 2 | 3 | 4 | 5 | 6 | 7 | 8 | 9 |
| 1 | 1 | # | ' | , | - | . | & | | |
| 2 | A | B | C | 2 | a | b | c | | |
| 3 | D | E | F | 3 | d | e | f | | |
| 4 | G | H | I | 4 | g | h | i | | |
| 5 | J | K | L | 5 | j | k | l | | |
| 6 | M | N | O | 6 | m | n | o | | |
| 7 | P | Q | R | S | 7 | p | q | r | s |
| 8 | T | U | V | 8 | t | u | v | | |
| 9 | W | X | Y | Z | 9 | w | x | y | z |
| 0 | 0 | | | | | | | | |
| * | . | ? | ! | / | (|) | @ | | |
| # | space | | | | | | | | |

8. Press **MENU/SELECT** to store your new directory entry. The name and the telephone number appear. To change them later, see page 29.



Review directory

To review directory entries

1. Press **DIR▲** when in idle mode to show the first entry in the directory.
DIRECTORY EMPTY appears if there are no directory entries.

-OR-

You can also show the first entry in the directory by pressing **MENU/SELECT** when in idle mode, then press **MENU/SELECT** twice.

2. Press **▼CID** or **DIR▲** to browse through the directory. Entries appear alphabetically by the first letter in the name.

 **NOTE:** If the telephone number in the directory exceeds 15 digits, <* appears in front of the telephone number. Press * to move towards the end of the telephone number or press # to move towards the beginning of the telephone number.

Search directory

To search by name

1. Press **DIR▲** in idle mode to show the first listing in the directory.
DIRECTORY EMPTY appears if there are no directory entries.
2. When a name entry appears, press the dial pad keys (2-9) to start a name search.

The directory shows the first name beginning with the first letter associated with the dial pad key if there is an entry in the directory beginning with that letter.

3. To see other names starting with the letters on the same dial pad key, keep pressing the key. The names appear in alphabetical order.

For example, if you have the names **Jennifer**, **Jessie**, **Kevin** and **Linda** in your directory:

- If you press **5 (JKL)** once, you see **Jennifer**.
- If you press **5 (JKL)** twice, you see **Jessie**.
- If you press **5 (JKL)** three times, you see **Kevin**.
- If you press **5 (JKL)** four times, you see **Linda**.
- If you press **5 (JKL)** five times, you see **Jennifer** again.



NOTES:



1. If there is no name matching the first letter of the key you press, the directory shows a name matching the following letters of the key.
2. If you press a key (2-9) and no name starts with the letters on that key, the directory shows the entry matching the next letter in the directory.

Directory

To dial, delete or edit entries

To dial, delete or edit a directory entry (name and number), the entry must be shown on the handset. Use the directory review or search (pages 27-28) to show an entry.

Display dial

To dial a displayed number from the directory, press  **PHONE/FLASH** or  **SPEAKER**.

To delete an entry

When a directory entry appears, press **MUTE/DELETE** to delete the displayed entry from the directory. You cannot retrieve a deleted entry.

To edit an entry

When a directory entry appears:

1. Press **MENU/SELECT** to modify the entry. You need to **EDIT NUMBER**.

- Press the dial pad keys to add digits.
- Press **▼CID** or **DIR▲** to move the cursor to the left or right.
- Press **MUTE/DELETE** to erase digits.
- Press and hold **MUTE/DELETE** to erase all digits.
- Press and hold **REDIAL/PAUSE** to add a three-second pause, if desired.
- Copy a number from the redial list by pressing **REDIAL/PAUSE** then **▼CID** or **DIR▲**, or pressing **REDIAL/PAUSE** repeatedly to locate the number to copy. Press **MENU/SELECT** to copy the selected number.

2. Press **MENU/SELECT**. You need to **EDIT NAME**.

- Press the dial pad keys to add characters (page 26).
- Press **MUTE/DELETE** to erase characters.
- Press and hold **MUTE/DELETE** to erase all characters.
- Press **▼CID** or **DIR▲** to move the cursor to the left or right.

3. Press **MENU/SELECT** to confirm.

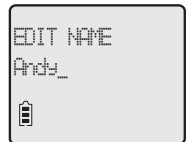
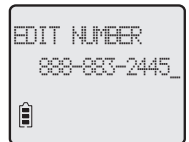

About caller ID

This product supports caller ID services offered by most telephone service providers. Depending on your service subscription, you might see the caller's number, or the caller's name and number from the telephone company after the first or second ring. Caller ID allows you to see the name, number, date, and time of calls.

Information about caller ID with call waiting

Caller ID with call waiting lets you see the name and telephone number of the caller before answering the telephone, even while on another call.

It might be necessary to change your telephone service to use this feature. Contact your telephone company if:

- You have both caller ID and call waiting, but as separate services (you might need to combine these services).
- You have only caller ID service, or only call waiting service.
- You don't subscribe to caller ID or call waiting services.

There are fees for caller ID services. In addition, services may not be available in all areas.

This product can provide information only if both you and the caller are in areas offering caller ID service and if both telephone companies use compatible equipment. The time and date are from the telephone company along with the call information.

Caller ID information might not be available for every incoming call. Callers may intentionally block their names and/or telephone numbers. To view call log entries with numbers between 16 and 23 digits, you must save the entry to the directory (see page 34)



i **NOTE:** You can use this product with regular caller ID service, or you can use this product's other features without subscribing to caller ID or combined caller ID with call waiting service.

Caller ID history

How the caller ID history (call log) works

The telephone stores caller ID information about the last 50 incoming calls in the telephone base. Entries are stored in reverse chronological order. The phone deletes the oldest entry when the log is full to make room for new calls. This information is common to all handsets, so changes made using any handset are reflected in all other handsets. If you answer a call before the information appears on the screen, it does not show in the caller ID history.

Review the caller ID history to find out who called, to easily return the call, or to copy the caller's name and number into your directory.

XX MISSED CALL(S) appears if there are new call log entries (including missed and unreviewed calls). **CALL LOG EMPTY** appears if there are no records in the call log.



NOTES:

1. Only one handset can review the caller ID history at a time. If another handset tries to enter the directory or caller ID history, it shows **NOT AVAILABLE AT THIS TIME**.
2. Each entry can have up to 24 digits for the phone number and 15 characters for the name. If the phone number has more than 15 digits, only the last 15 digits appear. For call log entries with numbers between 16 and 23 digits, in order to view the entire number, you must save the entry to the directory (see page 34). If the phone number has more than 24 digits, it is not saved or shown in the call log.
3. The caller ID information might not be available for every incoming call. The callers might intentionally block their names and/or telephone numbers.

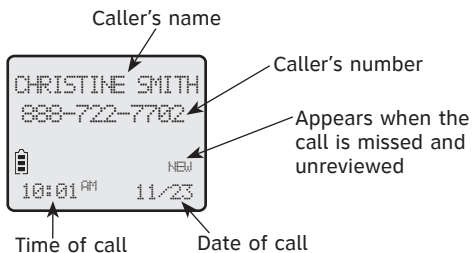

Caller ID history

Memory match

If the incoming telephone number exactly matches a telephone number in your directory, the name that appears on the screen matches the corresponding name in your directory.

For example, if Christine Smith calls, her name appears as Chris if this is how you entered it into your directory.



NOTE: The number you see on your caller ID is in the format from the phone company. The phone company usually delivers ten-digit phone numbers (area code plus phone number). If the telephone number of the caller does not exactly match a number in your directory, the name appears the same from the phone company. For example, if the phone company includes the area code and the directory number does not, the name is the one which the phone company sends.



Missed (new) calls indicator

When a handset is in idle mode and has unreviewed calls, its screen shows **XX MISSED CALLS**.

All unreviewed entries are counted as missed calls. Each time you review a call log entry with the icon **NEW**, the number of missed calls decreases by one.

If you do not want to review the missed calls one by one, but you still want to keep them in the caller ID history, you can press and hold **OFF/CLEAR** for four seconds when the handset is idle. All the entries in the caller ID history become old (have been reviewed), and the missed calls counter shows 0.

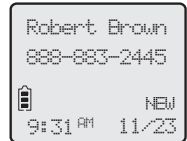

Caller ID history

To review the caller ID history

1. When a handset is in idle mode, press **▼CID** to review the caller ID history in reverse chronological order starting with the most recent call.

-OR-

You can also review the caller ID history by pressing **MENU/SELECT**, then press **▼CID** or **DIR▲** to scroll to **>CALL LOG**, then press **MENU/SELECT** twice to **REVIEW**.

2. Press **▼CID** or **DIR▲** to scroll through the list.

3. Press **☎ OFF/CLEAR** to exit the caller ID history.

You hear a double beep when the list reaches the beginning or end of the call log.

Make a call log entry ready to dial

Although the incoming call log entries have 10 digits (the area code plus the seven-digit number), in some areas, you might need to dial only the seven digits, 1 plus the seven digits, or 1 plus the area code plus the seven digits. You can change and store the number of digits that you dial in the call log.

While reviewing the call log, press **#** repeatedly to show different dialing options for local and long distance numbers before dialing or saving the telephone number in the directory.

Press **1** repeatedly if you need to add or remove 1 in front of the telephone number before dialing or saving it in the directory.

When the number shows in the correct format for dialing, press

☎ PHONE/FLASH or **🔊 SPEAKER** to call the number.

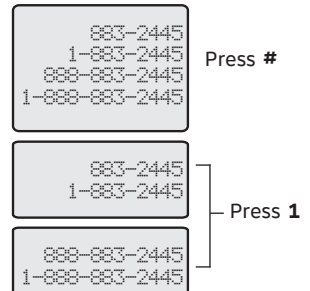

Caller ID history

Dial a call log entry

1. When in the call log, press **▼CID** or **DIR▲** to browse.
2. Press **☎ PHONE/FLASH** or **🔊 SPEAKER** to dial the entry.

Delete entries

- Press **MUTE/DELETE** to delete the shown entry from the caller ID history.
- Follow the steps below to delete all caller ID history.
 1. Press **MENU/SELECT** when in idle mode
 2. Press **▼CID** or **DIR▲** to scroll to **>CALL LOG**, then press **MENU/SELECT**.
 3. Press **▼CID** or **DIR▲** to scroll to **>DEL ALL CALLS**, then press **MENU/SELECT**.
 4. When the screen shows **DELETE ALL CALLS?** press **MENU/SELECT** to clear the caller ID history of all entries, or press **☎ OFF/CLEAR** to exit and leave all entries in the caller ID history intact.

Save a call log entry to the directory

1. When in the call log, press **▼CID** or **DIR▲** to browse.
2. Press **MENU/SELECT** to select an entry. The screen displays **EDIT NUMBER**.
3. Use the dialing keys to edit the number.
 - Press **▼CID** or **DIR▲** to move the cursor to the left or right.
 - Press **MUTE/DELETE** to backspace and erase a digit.
 - Press and hold **MUTE/DELETE** to erase the entire entry.
 - Press and hold **REDIAL/PAUSE** to insert a dialing pause (**p** appears).
 - Copy a number from the redial list by pressing **REDIAL/PAUSE** then **▼CID** or **DIR▲**, or by pressing **REDIAL/PAUSE** repeatedly to select a number. Press **MENU/SELECT** to copy the number.
4. Press **MENU/SELECT** to move to the name. The screen displays **EDIT NAME**.
 - Press the dial pad keys to add characters (page 26).
 - Press **▼CID** or **DIR▲** to move the cursor to the left or right.
 - Press **MUTE/DELETE** to erase characters.
 - Press and hold **MUTE/DELETE** to erase all characters.
5. Press **MENU/SELECT** when done and the handset shows **SAVED**.
 - If the entry is already saved in the directory, the handset shows **ALREADY SAVED**.
 - If there is no caller ID information, the handset shows **UNABLE TO SAVE**.



NOTES:

1. You might need to change how a caller ID number is dialed if the entry does not appear in the correct format. Caller ID numbers might appear with an area code that might not be necessary for local calls, or without a 1 that might be necessary for long distance calls (page 33).
2. If neither the name nor number is available, **UNABLE TO SAVE** appears.





Reasons for missing caller ID information

There are also occasions when other information or no information shows for various reasons:

| On-screen message | Reason |
|-------------------|---|
| PRIVATE NUMBER | The caller prefers not to show the phone number. |
| PRIVATE NAME | The caller prefers not to show the name. |
| PRIVATE CALLER | The caller prefers not to show the phone number and name. |
| UNKNOWN NUMBER | Your telephone service provider cannot determine the caller's number. |
| UNKNOWN NAME | Your telephone service provider cannot determine the caller's name. |
| UNKNOWN CALLER | Your telephone service provider cannot determine the caller's name and telephone number. Calls from other countries may also generate this message. |

Alert tones and lights

Screen icons

| | |
|--|---|
|  | Battery status - battery is charging (animated display). |
|  | Battery status - low battery (flashing); place handset in telephone base or charger to recharge. |
|  | SPEAKERPHONE - the speakerphone is in use. |
|  | Ringer off - the handset ringer is off. |
|  | NEW VOICEMAIL - there are new voicemail from the telephone service provider. |
| NEW | Missed and unreviewed calls. |
| MUTE | Microphone is off. |



Handset alert tones

| | |
|--------------------|---|
| Two short beeps | You are pressing the ▼CID or DIR▲ keys when the volume is already at its highest or lowest setting. |
| Four short beeps | Low battery warning. |
| Three beeps | Out of range while the handset is on a call. |
| Three rising tones | The system has completed the command successfully. |

Lights

IN USE

On when the handset is in use or when you are registering a handset.

Flashes when another telephone is in use on the same line, or when you are deregistering handset(s) from the telephone base.

Flashes quickly when there is an incoming call.

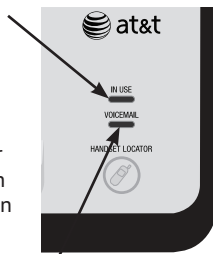

VOICEMAIL

Flashes when you have new voicemail. Voicemail service is from your telephone service provider.

CHARGE

On when the handset is charging in the telephone base or charger.

Lighted display

Lighted dial pad

►) SPEAKER

On when the speakerphone is on.



Handset display screen messages

Screen display messages

| | |
|--|--|
| ALREADY SAVED | The telephone number you have entered is already in the directory. |
| CALL LOG EMPTY | You are trying to reach an empty caller ID history. |
| CALL TRANSFERED | You are transferring an outside call from one handset to another handset. |
| CALLING HANDSET X (For systems with three or more handsets) | The handset is calling the other handset (for intercom calls). |
| CALLING OTHER HANDSET (For system with two handsets) | The handset is calling the other handset (for intercom calls). The handset is going to transfer an outside call to another handset. |
| CHARGING | A handset with a low battery is in the telephone base or charger. |
| CONNECTING... | The handset has lost communication with the telephone base. |
| DIRECTORY EMPTY | There are no directory entries. |
| ENDED | You have just ended a call. |
| HANDSET X IS CALLING (For systems with three or more handsets) | Another system handset is calling. |
| HANDSET X REGISTERED | The handset registration is successful, with X being the handset number. |
| INCOMING CALL | There is a call coming in. |
| INTERCOM | The handset is on an intercom call. |
| INTERCOM ENDED | The intercom call has just ended. |
| INTERCOM TO: (For systems with three or more handsets) | You have started the intercom process, and need to enter the number of the handset you wish to call. |
| LINE IN USE | An extension phone or one of the handsets is in use. |
| LIST FULL | The directory is full. You cannot save any new entries unless you delete some current entries. |

Handset display screen messages

Screen display messages

| | |
|--|---|
| LOW BATTERY | You should charge the battery. |
| MICROPHONE ON | Mute is off so the other party can hear your voice. |
| XX MISSED CALLS | There are new calls in the caller ID history. |
| MUTED | The microphone is off. |
| NEW VOICEMAIL | There are new voicemail messages. |
| NO LINE | There is no telephone line connection. |
| NO SIGNAL, CALL ENDED | The handset is out of range while on a call. |
| NOT AVAILABLE AT THIS TIME | Someone else is already using the directory or caller ID history. |
| OTHER HANDSET IS CALLING (For system with two handsets) | The other handset is calling. |
| OUTSIDE CALL | You are on the external call during call transfer. |
| ** PAGING ** | The telephone base is paging the handset. |
| PHONE | The handset is in use. |
| PLACE IN CHARGER | The battery is very low. The handset should be in the telephone base or charger. |
| RINGER MUTE | The ringer is off temporarily during an incoming call. |
| SAVED | The entry in caller ID history is now in the directory. |
| SPEAKER | The handset speakerphone is in use. |
| TRANSFER TO: (For systems with three or more handsets) | You have started transferring a call, and need to enter the desired handset number. |
| UNABLE TO CALL TRY AGAIN | Failed intercom or conference call (there are already two handsets being used). |
| UNABLE TO SAVE | You are trying to save an entry with no name and number from the caller ID history. |

Expansion handset

Your new AT&T CL81109/CL81209/CL81219/CL81309 telephone system can accommodate up to 12 handsets. You can add new handsets (AT&T CL80109, available separately) to your telephone system, you must register each device with the telephone base before use. To register a new handset, see page 40.

The handset with the CL81109 comes as **HANDSET**. You can register up to 11 additional handsets to the telephone base, and they are assigned numbers in sequential order (**HANDSET 2, HANDSET 3, HANDSET 4** and so on).

The handsets that come with the CL81209/CL81219 are **HANDSET 1** and **HANDSET 2**. You can register up to 10 additional handsets to the telephone base, and they are assigned numbers in sequential order (**HANDSET 3, HANDSET 4, HANDSET 5** and so on).

The handsets that come with the CL81309 are **HANDSET 1, HANDSET 2** and **HANDSET 3**. You can register up to nine additional handsets to the telephone base, and they are in sequential order (**HANDSET 4, HANDSET 5, HANDSET 6** and so on).

Expansion handset

Adding and registering handsets (optional)

Handsets purchased separately (AT&T CL80109) need to be registered to the telephone base before use. When first purchased, all expansion handsets show **NOT REGISTERED** on the screen. New handsets may need to be charged without interruption for at least 30 minutes before registering to the telephone base.

**To register a handset to your telephone base**

1. Make sure the handset is out of the telephone base or charger and shows **NOT REGISTERED** before you begin registration.
2. Press and hold  **HANDSET LOCATOR** on the telephone base for about four seconds (until the red **IN USE** light on the telephone base is on) and then release the button. The **IN USE** light remains on while the telephone base attempts to register a handset.
3. Place the unregistered handset into the telephone base or charger, **PRESS HNDST LOC 4 SEC ON BASE** shows on the handset screen. The handset is now registering with the telephone base. The handset then shows **PLEASE WAIT...** and it takes up to 60 seconds to complete the registration. There is a beep sound when the registration is successful. The handset shows **HANDSET X REGISTERED**, with **X** being the handset number (1-12).

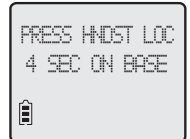
**NOTES:**

1. If the registration is not successful, the screen shows **NOT REGISTERED**. To reset the handset, remove the handset from the telephone base or charger, then start again from step 2 above.
2. You cannot register a handset if any other system handset is in use.

Expansion handset

Deregistering a handset

You can deregister handsets. You may need to deregister your handsets if:

You have twelve registered handsets and need to replace a handset.





-OR-

You wish to change the designated handset number of your registered handsets.

You must first deregister ALL the handsets, and then re-register each handset you wish to use.



Please read carefully through all the instructions on this page before beginning the deregistration process.

To deregister all handsets

1. Press and hold  **HANDSET LOCATOR** on the telephone base for about 10 seconds (until the **IN USE** light starts to flash), then release the  **HANDSET LOCATOR** button.
2. Immediately press and release  **HANDSET LOCATOR** again. You must press  **HANDSET LOCATOR** while the **IN USE** light is still flashing. (The light flashes for about seven seconds. If the light stops flashing, pick up the handset and place it back into the telephone base, then start again with step one above.)
3. The handset(s) shows **CONNECTING...** and it takes about 10 seconds to complete the deregistration process. ALL handsets shows **NOT REGISTERED** when deregistration is successful.
4. To re-register the handset(s) to the telephone base, follow the registration instructions on page 40.



NOTES:

1. If the deregistration process is not successful, you might need to reset the system and try again. To reset: pick up the handset and press the  **PHONE/FLASH** button, then press the  **OFF/CLEAR** button and place the handset back into the telephone base. You can also reset by unplugging the power from the telephone base and plugging it back in.
2. You cannot deregister the handset(s) if any other system handset is in use.
3. Even if the battery is depleted, you can still deregister the handset by following the steps above. After the handset is charged for at least 30 minutes, the screen shows **NOT REGISTERED**.

Troubleshooting

If you have difficulty with your phone, please try the suggestions below. For Customer Service, visit our website at **www.telephones.att.com** or call **1 (800) 222-3111**. In Canada, dial **1 (866) 288-4268**.

My phone doesn't work at all.

- Make sure the power cord is securely plugged in.
- Make sure you plug the battery connector securely into the cordless handset.
- Make sure you plug the telephone line cord securely and firmly into the telephone base and the telephone wall jack.
- Charge the battery in the cordless handset for at least 16 hours. For optimum daily performance, return the cordless handset to the telephone base or charger when not in use.
- If the battery is depleted, it might take approximately 30 minutes to charge the handset before it shows **LOW BATTERY**, refer to the table on page 7 for details.
- Reset the telephone base. Unplug the electrical power. Wait for approximately 15 seconds, then plug it back in. Allow up to one minute for the cordless handset and telephone base to reset.
- You may need to purchase a new battery. Please refer to **Battery installation & charging** in this user's manual on pages 7-8.

I cannot get a dial tone.

- First try all the suggestions above.
- Move the cordless handset closer to the telephone base. You might have moved out of range.
- If the previous suggestions do not work, disconnect the telephone base from the telephone jack and connect to a different phone. If there is no dial tone on that phone either, the problem is in your wiring or local service. Contact your telephone service provider.
- Your line cord might be malfunctioning. Try installing a new line cord.

Appendix D Troubleshooting

I cannot dial out.

- First try all the suggestions above.
- Make sure you have a dial tone before dialing. The cordless handset might take a second or two to find the telephone base and produce a dial tone. This is normal. Wait an extra second before dialing.
- Eliminate any background noise. Noise from a television, radio or other appliances might cause the phone to not dial out properly. If you cannot eliminate the background noise, first try muting the cordless handset before dialing, or dialing from another room with less background noise.
- If the other phones in your home are having the same problem, contact your telephone service provider (charges might apply).

My cordless handset isn't performing normally.

- Make sure you plug the power cord securely into the telephone base. Plug the power adapter into a different, working electrical outlet without a wall switch.
- Move the cordless handset closer to the telephone base. You might have moved out of range.
- Reset the telephone base. Unplug the electrical power. Wait for 15 seconds then plug it back in. Allow up to one minute for the cordless handset and telephone base to reset.
- Other electronic products can cause interference to your cordless phone. Try installing your phone as far away from these types of electronic devices as possible: television sets, VCRs, or other cordless telephones.

The handset registration is unsuccessful.

Follow the steps below to re-register the handset.

1. Make sure the handset is out of the telephone base or charger and shows **NOT REGISTERED** before you begin registration.
2. Press and hold  **HANDSET LOCATOR** for about four seconds (until the red **IN USE** light on the telephone base is on) and then release the button.

Troubleshooting

3. Place the unregistered handset into telephone base or charger.

Refer to the handset registration section on page 40 for details.

The handset screen shows **PRESS HANDST LOC 4 SEC ON BASE** and the handset is out of the telephone base or charger.

Unplug the battery from the handset and plug it back in (page 7). The screen should now show **NOT REGISTERED** and you can follow the registration instructions on page 40.

CONNECTING... appears on my cordless handset.

- Ensure you plug the telephone base in properly and the power is on.
 - Place the cordless handset in the telephone base for one minute to allow the cordless handset and base to synchronize.
 - Move the cordless handset closer to the telephone base. You might have moved out of range.
 - Reset the telephone base. Unplug the electrical power. Wait for 15 seconds then plug it back in. Allow up to one minute for the cordless handset and telephone base to reset.
 - Other electronic products can cause interference with your cordless phone. Try installing your phone as far away from these types of electronic devices as possible: television sets, VCRs, or other cordless telephones.
-

The batteries do not hold a charge.

- If the cordless handset is in the telephone base or charger and the charge light is not on, refer to **The charge light is off** (page 47) in this **Troubleshooting** guide.
- Charge the battery in the cordless handset for at least 16 hours. For optimum daily performance, return the cordless handset to the telephone base or charger when not in use.

Appendix D Troubleshooting

- If the battery is depleted, it might take approximately 30 minutes to charge the handset before it shows **LOW BATTERY**, refer to the table on page 7 for details.
- You might need to purchase a new battery. Please refer to **Battery installation & charging** in this user's manual on pages 7-8.

I get noise, static, or weak signals even when I'm near the telephone base.

- If you subscribe to high-speed Internet service (digital subscriber line - DSL) through your telephone lines, you must install a DSL filter between the telephone base and the telephone wall jack. The filter prevents noise and caller ID problems as a result of DSL interference. Please contact your DSL service provider for more information about DSL filters.
- You may be able to improve the performance of your cordless phone by installing your new telephone base as far as possible from any other existing cordless telephone system that may already be installed.
- Other electronic products can cause interference to your cordless phone. Try installing your phone as far away from the following electronic devices as possible: television sets, VCRs, or other cordless telephones.
- Do not install this phone near a microwave oven or on the same electrical outlet. You might experience decreased performance while the microwave oven is operating.
- If you plug your phone in with a modem or a surge protector, plug the phone (or modem/surge protector) into a different location. If this does not solve the problem, re-locate your phone or modem farther apart from one another, or use a different surge protector.
- Relocate your phone to a higher location. The phone might have better reception in a high area.
- If the other phones in your home are having the same problem, contact your telephone service provider (charges may apply).

Troubleshooting

I experience poor sound quality when using the speakerphone.

- For increased sound quality while using the speakerphone, place the handset on a flat surface with the dial pad facing up.

I hear other calls while using my phone.

- Disconnect the telephone base from the telephone jack, and plug in a different telephone. If you still hear other calls, call your telephone service provider.

My cordless handset does not ring when I receive a call.

- Make sure that the ringer is not off. Refer to the section on ringer selection in this user's manual.
- Make sure you plug in the telephone line cord securely into the telephone base and the telephone jack. Make sure you plug in the power cord securely.
- The cordless handset may be too far from the telephone base.
- Charge the battery in the cordless handset for at least 16 hours. For optimum daily performance, return the cordless handset to the telephone base or charger when not in use.
- You may have too many extension phones on your telephone line to allow all of them to ring simultaneously. Try unplugging some of the other phones.
- The layout of your home or office might be limiting the operating range. Try moving the telephone base to another location, preferably on an upper floor.
- If the other phones in your home are having the same problem, contact your telephone service provider (charges might apply).
- Test a working phone at the phone jack. If another phone has the same problem, contact your telephone service provider (charges might apply).
- Other electronic products can cause interference with your cordless phone. Try installing your phone as far away as possible from electronic devices such as television sets, VCRs, or other cordless telephones.

Appendix D

Troubleshooting

- Re-install the battery, and place the cordless handset in the telephone base. Wait for the cordless handset to re-establish its connection with the telephone base. Allow up to one minute for this to take place.
- Your line cord might be malfunctioning. Try installing a new line cord.

My calls cut in and out while I'm using my cordless handset.

- Other electronic products can cause interference with your cordless phone. Try installing your phone as far away from the following electronic devices as possible: television sets, VCRs, or other cordless telephones.
- Do not install this phone near a microwave oven or on the same electrical outlet. You might experience decreased performance while the microwave oven is operating.
- If you plug your phone in with a modem or surge protector, plug the phone (or modem/surge protector) into a different location. If this does not solve the problem, re-locate your phone or modem farther apart from one another, or use a different surge protector.
- Relocate your telephone base to a higher location. The phone might have better reception when installed in a high area.
- If the other phones in your home are having the same problem, contact your telephone service provider (charges may apply).

The charge light is off.

- Make sure you plug the power and line cords in correctly and securely.
- Unplug the electrical power. Wait for 15 seconds, then plug it back in. Allow up to one minute for the cordless handset and telephone base to reset.
- Clean the cordless handset and telephone base charging contacts each month with a pencil eraser or cloth.

Troubleshooting

My caller ID isn't working.

- Caller ID is a subscription service. You must subscribe to this service from your telephone service provider for this feature to work on your phone.
 - The caller must be calling from an area that supports caller ID.
 - Both you and your caller's telephone companies must use caller ID compatible equipment.
 - If you subscribe to high-speed Internet service (digital subscriber line - DSL) through your telephone lines, you must install a DSL filter between the telephone base and the telephone wall jack. The filter prevents noise and caller ID problems resulting from DSL interference. Please contact your DSL service provider for more information about DSL filters.
-

System does not receive caller ID when on a call.

- Make sure you subscribe to caller ID with call waiting features from your telephone service provider. Caller ID features works only if both you and the caller are in areas offering caller ID service, and if both telephone companies use compatible equipment.
-

Common cure for electronic equipment.

If the telephone does not seem to be responding normally, try putting the cordless handset in the telephone base or charger. If it does not seem to respond, do the following (in the order listed):

- Disconnect the power to the telephone base.
- Disconnect the cordless handset battery, and spare battery, if applicable.
- Wait a few minutes.
- Connect power to the telephone base.
- Re-install the battery, and place the cordless handset into the telephone base.
- Wait for the cordless handset to re-establish its connection with the telephone base. Allow up to one minute for this to take place.

Troubleshooting

I subscribe to a non-traditional telephone service that uses my computer to establish connections, and my telephone doesn't work.

- Make sure your computer is powered on.
- Make sure your Internet connection is working properly.
- Make sure that the software is installed and running for your non-traditional telephone service.
- Make sure to plug your USB telephone adapter into a dedicated USB port on your computer. Do not plug into a multiple port USB hub (USB splitter) that is not powered.
- In a few rare instances, the USB port on your computer may not have enough power. In these instances, try using a USB hub with its own external power supply.
- If you are using a firewall, it may prevent access to your non-traditional telephone service provider. Contact your service provider for more information.

Appendix E

Maintenance

Taking care of your telephone

- Your cordless telephone contains sophisticated electronic parts, so you must treat it with care.
- Avoid rough treatment.
- Place the handset down gently.
- Save the original packing materials to protect your telephone if you ever need to ship it.

Avoid water

- You can damage your telephone if it gets wet. Do not use the handset in the rain, or handle it with wet hands. Do not install the telephone base near a sink, bathtub or shower.

Electrical storms

- Electrical storms can sometimes cause power surges harmful to electronic equipment. For your own safety, take caution when using electric appliances during storms.

Cleaning your telephone

- Your telephone has a durable plastic casing that should retain its luster for many years. Clean it only with a soft cloth slightly dampened with water or a mild soap.
- Do not use excess water or cleaning solvents of any kind.

Remember that electrical appliances can cause serious injury if used when you are wet or standing in water. If the telephone base should fall into water, DO NOT RETRIEVE IT UNTIL YOU UNPLUG THE POWER CORD AND TELEPHONE LINE CORDS FROM THE WALL. Then pull the unit out by the unplugged cords.

Important safety information



This symbol is to alert you to important operating or servicing instructions that may appear in this user's manual. Always follow basic safety precautions when using this product to reduce the risk of injury, fire, or electric shock.

Safety information

- Read and understand all instructions in the user's manual. Observe all markings on the product.
- Avoid using a telephone during a thunderstorm. There may be a slight chance of electric shock from lightning.
- Do not use a telephone in the vicinity of a gas leak. If you suspect a gas leak, report it immediately, but use a telephone away from the area where the gas is leaking. If this product is a cordless model, make sure the telephone base is also away from the area.
- Do not use this product near water, or when you are wet. For example, do not use it in a wet basement or shower, or next to a swimming pool, bathtub, kitchen sink, or laundry tub. Do not use liquids or aerosol sprays for cleaning. If the product comes in contact with any liquid, unplug any line or power cord immediately. Do not plug the product back in until it has dried thoroughly.
- Install this product in a protected location where no one can trip over any line or power cords. Protect cords from damage or abrasion.
- If this product does not operate normally, see the **Troubleshooting** section on pages 42-49 of this user's manual. If you cannot solve the problem, or if the product is damaged, refer to the **Limited warranty** section on pages 56-57. Do not open this product except as directed in your user's manual. Opening the product or reassembling it incorrectly may expose you to hazardous voltages or other risks.
- Replace batteries only as described in your user's manual, see pages 7-8. Do not burn or puncture batteries — they contain caustic chemicals.
- This power adapter is intended to be correctly oriented in a vertical or floor mount position. The prongs are not designed to hold the plug in place if it is plugged into a ceiling or an under-the-table/cabinet outlet.



Caution: Use only the power adapter provided with this product. To obtain a replacement, visit our website at **www.telephones.att.com** or call **1 (800) 222-3111**. In Canada, dial **1 (866) 288-4268**.

Important safety information

Especially about cordless telephones

- **Privacy:** The same features that make a cordless telephone convenient create some limitations. Telephone calls are transmitted between the telephone base and the handset by radio waves, so there is a possibility that your cordless telephone conversations could be intercepted by radio receiving equipment within range of the cordless handset. For this reason, you should not think of cordless telephone conversations as being as private as those on corded telephones.
- **Electrical power:** The telephone base of this cordless telephone must be connected to a working electrical outlet which is not controlled by a wall switch. Calls cannot be made from the handset if the telephone base is unplugged, switched off or if the electrical power is interrupted.
- **Potential TV interference:** Some cordless telephones operate at frequencies that may cause interference to TVs and VCRs. To minimize or prevent such interference, do not place the telephone base of the cordless telephone near or on top of a TV or VCR. If interference is experienced, moving the cordless telephone farther away from the TV or VCR will often reduce or eliminate the interference.
- **Rechargeable batteries:** This product contains nickel-metal hydride rechargeable batteries. Exercise care in handling batteries in order not to create a short circuit with conductive material such as rings, bracelets, and keys. The battery or conductor may overheat and cause harm. Observe proper polarity between the battery and the battery charger.
- **Nickel-metal hydride rechargeable batteries:** Dispose of these batteries in a safe manner. Do not burn or puncture. Like other batteries of this type, if burned or punctured, they could release caustic material which could cause injury.



The RBRC™ Seal means that the manufacturer is voluntarily participating in an industry program to collect and recycle nickel-metal hydride rechargeable batteries when taken out of service within the United States. These batteries may be taken to a participating local retailer of replacement batteries or recycling center. Or you may call 1 (800) 8-BATTERY for locations accepting spent Ni-MH batteries.

Precautions for users of implanted cardiac pacemakers

Cardiac pacemakers (applies only to digital cordless telephones):

Wireless Technology Research, LLC (WTR), an independent research entity, led a multidisciplinary evaluation of the interference between portable wireless telephones and implanted cardiac pacemakers. Supported by the U.S. Food and Drug Administration, WTR recommends to physicians that:

Pacemaker patients

Should keep wireless telephones at least six inches from the pacemaker.

Should NOT place wireless telephones directly over the pacemaker, such as in a breast pocket, when it is turned ON.

Should use the wireless telephone at the ear opposite the pacemaker.

WTR's evaluation did not identify any risk to bystanders with pacemakers from other persons using wireless telephones.

SAVE THESE INSTRUCTIONS

Appendix G

FCC Part 68 and ACTA

This equipment complies with Part 68 of the FCC rules and with technical requirements adopted by the Administrative Council for Terminal Attachments (ACTA). The label on the back or bottom of this equipment contains, among other things, a product identifier in the format US:AAAEQ##TXXXX. This identifier must be provided to your telephone service provider upon request.

The plug and jack used to connect this equipment to premises wiring and the telephone network must comply with the applicable Part 68 rules and technical requirements adopted by ACTA. A compliant telephone cord and modular plug is provided with this product. It is designed to be connected to a compatible modular jack that is also compliant. An RJ11 jack should normally be used for connecting to a single line and an RJ14 jack for two lines. See Installation Instructions in the user's manual.

The Ringer Equivalence Number (REN) is used to determine how many devices you may connect to your telephone line and still have them ring when you are called. The REN for this product is encoded as the 6th and 7th characters following the US: in the product identifier (e.g., if ## is 03, the REN is 0.3). In most, but not all areas, the sum of all RENs should be five (5.0) or less. For more information, please contact your telephone service provider.

This equipment may not be used with Party Lines. If you have specially wired alarm dialing equipment connected to your telephone line, ensure the connection of this equipment does not disable your alarm equipment. If you have questions about what will disable the alarm equipment, consult your telephone company or a qualified installer.

If this equipment is malfunctioning, it must be unplugged from the modular jack until the problem has been corrected. Repairs to this telephone equipment can only be made by the manufacturer or its authorized agents. For repair procedures, follow the instructions outlined under the Limited Warranty.

If this equipment is causing harm to the telephone network, the telephone company may temporarily discontinue your telephone service. The telephone company is required to notify you before interrupting service. If advance notice is not practical, you will be notified as soon as possible. You will be given the opportunity to correct the problem and the telephone company is required to inform you of your right to file a complaint with the FCC. Your telephone company may make changes in its facilities, equipment, operation, or procedures that could affect the proper functioning of this product. The telephone company is required to notify you if such changes are planned.

If this product is equipped with a corded or cordless handset, it is hearing aid compatible.

If this product has memory dialing locations, you may choose to store emergency telephone numbers (e.g., police, fire, medical) in these locations. If you do store or test emergency numbers, please:

Remain on the line and briefly explain the reason for the call before hanging up.

Perform such activities in off-peak hours, such as early morning or late evening.

FCC Part 68 and ACTA

Industry Canada

Operation is subject to the following two conditions: (1) this device may not cause harmful interference, and (2) this device must accept any interference, including interference that may cause undesired operation.

The term "IC:" before the certification/registration number only signifies that the Industry Canada technical specifications were met.

The Ringer Equivalence Number (REN) for this terminal equipment is 0.1. The REN is an indication of the maximum number of devices allowed to be connected to a telephone interface. The termination on an interface may consist of any combination of devices subject only to the requirement that the sum of the RENs of all the devices does not exceed five.

This product meets the applicable Industry Canada technical specifications.

Appendix H

FCC Part 15

This equipment has been tested and found to comply with the requirements for a Class B digital device under Part 15 of the Federal Communications Commission (FCC) rules. These requirements are intended to provide reasonable protection against harmful interference in a residential installation. This equipment generates, uses and can radiate radio frequency energy and, if not installed and used in accordance with the instructions, may cause harmful interference to radio communications. However, there is no guarantee that interference will not occur in a particular installation. If this equipment does cause harmful interference to radio or television reception, which can be determined by turning the equipment off and on, the user is encouraged to try to correct the interference by one or more of the following measures:

- Reorient or relocate the receiving antenna.
- Increase the separation between the equipment and receiver.
- Connect the equipment into an outlet on a circuit different from that to which the receiver is connected.
- Consult the dealer or an experienced radio/TV technician for help.

Changes or modifications to this equipment not expressly approved by the party responsible for compliance could void the user's authority to operate the equipment.

This device complies with Part 15 of the FCC Rules. Operation is subject to the following two conditions: (1) this device may not cause harmful interference, and (2) this device must accept any interference received, including interference that may cause undesired operation. Privacy of communications may not be ensured when using this telephone.

To ensure safety of users, the FCC has established criteria for the amount of radio frequency energy that can be safely absorbed by a user or bystander according to the intended usage of the product. This product has been tested and found to comply with the FCC criteria. The handset may be safely held against the ear of the user. The telephone base shall be installed and used such that parts of the user's body other than the hands are maintained at a distance of approximately 20 cm (8 inches) or more.

This Class B digital apparatus complies with Canadian ICES-003.

Appendix I

Limited warranty

The AT&T brand is used under license - any repair, replacement or warranty service, and all questions about this product should be directed to: In the United States of America, visit www.telephones.att.com or call **1 (800) 222-3111**. In Canada, call **1 (866) 288-4268**.

1. What does this limited warranty cover?

The manufacturer of this AT&T-branded product warrants to the holder of a valid proof of purchase ("CONSUMER" or "you") that the product and all accessories provided in the sales package ("PRODUCT") are free from defects in material and workmanship, pursuant to the following terms and conditions, when installed and used normally and in accordance with the PRODUCT operating instructions. This limited warranty extends only to the CONSUMER for products purchased and used in the United States of America and Canada.

2. What will be done if the PRODUCT is not free from defects in materials and workmanship during the limited warranty period ("materially defective PRODUCT")?

During the limited warranty period, the manufacturer's authorized service representative will repair or replace at the manufacturer's option, without charge, a materially defective PRODUCT. If the manufacturer repairs the PRODUCT, they may use new or refurbished replacement parts. If the manufacturer chooses to replace the PRODUCT, they may replace it with a new or refurbished PRODUCT of the same or similar design. The manufacturer will retain defective parts, modules, or equipment. Repair or replacement of the PRODUCT, at the manufacturer's option, is your exclusive remedy. The manufacturer will return repaired or replacement products to you in working condition. You should expect the repair or replacement to take approximately 30 days.

3. How long is the limited warranty period?

The limited warranty period for the PRODUCT extends for ONE (1) YEAR from the date of purchase. If the manufacturer repairs or replaces a materially defective PRODUCT under the terms of this limited warranty, this limited warranty also applies to repaired or replacement PRODUCT for a period of either (a) 90 days from the date the repaired or replacement PRODUCT is shipped to you or (b) the time remaining on the original one-year limited warranty; whichever is longer.

4. What is not covered by this limited warranty?

This limited warranty does not cover:

- PRODUCT that has been subjected to misuse, accident, shipping or other physical damage, improper installation, abnormal operation or handling, neglect, inundation, fire, water, or other liquid intrusion; or
- PRODUCT that has been damaged due to repair, alteration, or modification by anyone other than an authorized service representative of the manufacturer; or
- PRODUCT to the extent that the problem experienced is caused by signal conditions, network reliability or cable or antenna systems; or
- PRODUCT to the extent that the problem is caused by use with non-AT&T accessories; or
- PRODUCT whose warranty/quality stickers, PRODUCT serial number plates or electronic serial numbers have been removed, altered or rendered illegible; or
- PRODUCT purchased, used, serviced, or shipped for repair from outside the United States of America or Canada, or used for commercial or institutional purposes (including but not limited to products used for rental purposes); or

Limited warranty

- PRODUCT returned without valid proof of purchase (see item 6 below); or
- Charges for installation or setup, adjustment of customer controls, and installation or repair of systems outside the unit.

5. How do you get warranty service?

To obtain warranty service in the United States of America, visit

www.telephones.att.com or call **1 (800) 222-3111**. In Canada, call

1 (866) 288-4268. NOTE: Before calling for service, please review the user's manual; a check of the PRODUCT controls and features may save you a service call.

Except as provided by applicable law, you assume the risk of loss or damage during transit and transportation and are responsible for delivery or handling charges incurred in the transport of the PRODUCT(s) to the service location. The manufacturer will return repaired or replaced PRODUCT under this limited warranty to you. Transportation, delivery or handling charges are prepaid. The manufacturer assumes no risk for damage or loss of the PRODUCT in transit. If the PRODUCT failure is not covered by this limited warranty, or proof of purchase does not meet the terms of this limited warranty, the manufacturer will notify you and will request that you authorize the cost of repair prior to any further repair activity. You must pay for the cost of repair and return shipping costs for the repair of products that are not covered by this limited warranty.

6. What must you return with the PRODUCT to get warranty service? You must:

- Return the entire original package and contents including the PRODUCT to the service location along with a description of the malfunction or difficulty; and
- Include "valid proof of purchase" (sales receipt) identifying the PRODUCT purchased (PRODUCT model) and the date of purchase or receipt; and
- Provide your name, complete and correct mailing address, and telephone number.

7. Other limitations

This warranty is the complete and exclusive agreement between you and the manufacturer of this AT&T branded PRODUCT. It supersedes all other written or oral communications related to this PRODUCT. The manufacturer provides no other warranties for this PRODUCT. The warranty exclusively describes all of the manufacturer's responsibilities regarding the PRODUCT. There are no other express warranties. No one is authorized to make modifications to this limited warranty and you should not rely on any such modification.

State/Provincial Law rights: This warranty gives you specific legal rights, and you may also have other rights which vary from state to state or province to province.

Limitations: Implied warranties, including those of fitness for a particular purpose and merchantability (an unwritten warranty that the PRODUCT is fit for ordinary use) are limited to one year from date of purchase. Some states/provinces do not allow limitations on how long an implied warranty lasts, so the above limitation may not apply to you. In no event shall the manufacturer be liable for any indirect, special, incidental, consequential, or similar damages (including, but not limited to lost profits or revenue, inability to use the PRODUCT or other associated equipment, the cost of substitute equipment, and claims by third parties) resulting from the use of this PRODUCT. Some states/provinces do not allow the exclusion or limitation of incidental or consequential damages, so the above limitation or exclusion may not apply to you.

Please retain your original sales receipt as proof of purchase.

Appendix J

Technical specifications

| | |
|---|-----------------------------|
| RF frequency band | 1921.536 MHz — 1928.448 MHz |
| Channels | 5 |
| Operating temperature | 32°F — 122°F 0°C — 50°C |
| Telephone base voltage (AC voltage, 60Hz) | 96 — 130 Vrms |
| Telephone base voltage (AC adapter output) | 6VAC @300mA |
| Handset voltage | 2.4 — 3.2 VDC |
| Charger voltage (AC adapter output) | 6VAC @300mA |

| Operation | Operating time* |
|--------------------------|-------------------|
| Talk time (handset) | Up to eight hours |
| Talk time (speakerphone) | Up to five hours |
| Standby | Up to six days |

* Operating times varies depending on your actual use and the age of the battery.

DECT 6.0 digital technology

The AT&T DECT 6.0 products offer unsurpassed range performance and sound clarity. This is achieved through a unique antenna design and advances in noise-filtering technology. An independent laboratory has confirmed that AT&T DECT 6.0 products perform up to 45% better in range competitions. Now calls can be taken in the basement, backyard and garage with exceptional sound quality.

Telephone operating range

This cordless telephone operates within the maximum power allowed by the Federal Communications Commission (FCC). Even so, this handset and telephone base can communicate over only a certain distance — which can vary with the locations of the telephone base and handset, the weather, and the construction of your home or office.

Redefining long range coverage and clarity

This telephone base comes with an antenna which gives much better clarity and covers a longer range than before.

Index

A

Alert, 36
Alert tones, 36
Answering calls, 16
Auto off, 16

B

Battery charging, 8
Battery installation, 7

C

Caller ID (CID),
 add entries to phone directory, 34
 delete entries, 34
 dial entries, 34
 review entries, 33
Caller ID, 30
Call transfer using intercom, 23
Call waiting, 18
Chain dialing, 19
Character chart, 26
Charger installation, 6
Clear voicemail indication, 14
Clock, 13

D

Day and time, 13
Deregistration, 41
Delete redial entries, 17
Dialing,
 directory dialing, 29
 from a record in the caller ID
 history, 34
Directory,
 dial number, 29
 edit entries, 29
 name search, 28
 new entries, 25
Display dial, 29
DSL, 4, 5

E

Elapsed time, 16
Ending calls, 16
Expansion handset, 39

F

Flash (switch hook flash), 18

H

Handset,
 deregistration, 41
 expansion, 39
 key tone, 12
 language, 12
 locator, 20
 quick reference guide, 1
 registration, 40
 ringer tone, 12
 ringer volume, 11
 screen display message, 37
 settings, 11
 speakerphone, 17
 status icons, 36
 temporary ringer silencing, 16
 voicemail indicator, 14

I

Important safety information, 51
Incoming caller ID history, 33
Incoming calls, answering, 16
Installation, 4
Intercom, 21

K

Key tone, 12

L

Language, 12
Last number redial, 17
Lights, 36

Index

Limited warranty, 56

M

Maintenance, 50

Making call, 16

Memory match, 32

Mute, 18

N

Names,

enter into directory, 26

search for, 28

O

On-hook dialing, 16

P

Paging tone, 20

Power adapter, 5, 6

Predialing, 16

Q

Quick reference guide, 1

R

Receiving calls, 16

Recharging, 8

Redial, 17

Registration, 40

Ringer silencing, 16

Ring tone options, 12

S

Safety information, 51

Search by name, 28

Speakerphone, 17

T

Technical specifications, 58

Telephone operating range, 58

Temporary ringer silencing, 16

Time, setting, 13

Troubleshooting, 42

V

Visual message waiting indicator, 14

Voicemail, 14

Volume control, 11

W

Wall-mount installation, 9

Warranty, 56



Proud Sponsor

www.telephones.att.com